

NASA CR-166,661



3 1176 00161 6706

**NASA CR 166661**

NASA-CR-166661

19810017132

---

**ELECTROMAGNETIC FIELD  
INTERACTIONS WITH THE  
HUMAN BODY: OBSERVED  
EFFECTS AND THEORIES**

NASA Purchase Order No. S-75151B

APRIL 1981



NF02174

---

Prepared For  
GODDARD SPACE FLIGHT CENTER  
GREENBELT, MARYLAND 20771

ELECTROMAGNETIC FIELD INTERACTIONS  
WITH THE HUMAN BODY: OBSERVED  
EFFECTS AND THEORIES

Jeremy K. Raines, Ph.D.

April 9, 1981

**DR. JEREMY K. RAINES, P.E.**  
*Electromagnetic & Communications Engineer*  
**13420 Cleveland Drive**  
**Rockville, Maryland 20850**

Report Prepared for:

National Aeronautics and Space Administration  
Goddard Space Flight Center  
Greenbelt, Maryland 20771

*NASA Purchase Order S-75151B*

*N81-25668#*

*Contents*

List of Figures	<i>ii.</i>
List of Tables	<i>v.</i>
Introduction	1.
Adverse, Benign, and Curious Effects	23.
Beneficial Effects	50.
Physical and Physiological Foundations	59.
Some Speculation and Areas for Further Research	95.
Acknowledgments	104.
References	105.
Bibliography	108.
Appendix	112.

*List of Figures*

FIGURE	PAGE
1. Electric Field Occurring Naturally at the Surface of the Earth	7.
2. Some Naturally Occurring Low Frequency Electric Fields with Electroencephalograms for Comparison	8.
3. Some Natural and Manmade Sources of Electromagnetic Radiation	9.
4. Incident Electromagnetic Radiation from the Proposed Solar Power Satellite	10.
5. Incident Electromagnetic Radiation from the Proposed Solar Power Satellite, at Distances Far from the Receiver	11.
6. Exposure Standards for Electromagnetic Radiation, with Emphasis on Duration of Exposure	17.
7. Exposure Standards for Electromagnetic Radiation, with Emphasis on Frequency and Duration of Exposure	18.
8. American National Standards Institute Proposed Exposure Standard for Electromagnetic Radiation	19.
9. The Electromagnetic Spectrum, Showing Ionizing and Nonionizing Regions	20.
10. Relation Between Naturally Occurring Magnetic Fields and Death Rate	38.
11. Effect of a 3-Hertz, Vertically Polarized, Electric Field on the Reaction Time of a Single Test Subject in a Single-Blind Experiment	39.
12. Effect of a 3-Hertz Electric Field on Galvanic Skin Response	40.
13. Effects of 2.5 Volt/Meter, 10-Hertz and 300 Volts/Meter, Static Electric Fields on Circadian Rhythm	41.
14. Changes in the Nervous and Cardiovascular Systems Among Workers Exposed to Microwaves and Control Subjects	46.
15. Occurrence of Headaches in "Microwave Workers"	47.
16. Occurrence of Excessive Perspiration in "Microwave Workers"	48.

FIGURE	PAGE
17. Substantially Flat Electroencephalograms of "Microwave Workers"	49.
18. Bean Bag Type Applicator for Hyperthermia	57.
19. Coaxial Type Applicator for Hyperthermia	58.
20. Electric Current Densities Produced When the Longitudinal Axis of the Human Body Is Parallel to Electric (E) and Magnetic (H) Fields	69.
21. Power Absorbed By a Human Body in the Far Field of an Electromagnetic Radiator, for Three Different Polarizations	70.
22. Multiple Cube Model Used for Detailed SAR Computations	72.
23. Calculated Nonuniform Distribution of Dissipated Power	73.
24. Calculated Nonuniform Distribution of Dissipated Power in Response to Uniform Incident Electromagnetic Field	74.
25. Dissipated Power As a Function of Frequency in Various Parts of the Human Body	75.
26. Calculated Current Densities in a Grounded Man in Response to a 60-Hertz, 10,000 Volt/Meter Electric Field	76.
27. Dielectric Properties of Human Brains in the Microwave S-Band, at 37 Degrees Centigrade	79.
28. Frequency Dependence of Muscle Tissue Dielectric Constant	80.
29. Pearl Chain Formation	81.
30. Steps in the Process of Pearl Chain Formation	82.
31. Electronic Circuit Model of an Individual Cell	83.
32. Voltage Across the Membrane of a Heart Muscle Cell	84.
33. Hodgkin-Huxley Circuit Model for a Cell Membrane	85.
34. Time-Dependent Conductances in the Circuit Model of a Cell Membrane	86.
35. Similarity of Cell Membrane to Space Charge Layer in an Electronic Semiconducting Device	87.
36. Space Charge Layer in a Semiconductor	88.
37. Lipids and Proteins in a Cell Membrane	89.

FIGURE		PAGE
38.	Chemical Composition of a Lipid Molecule	90.
39.	Chemical Composition of an Amino Acid from Which Proteins Are Constructed	91.
40.	Wide Range of Molecular Weights for Various Proteins	92.
41.	Some Molecular Responses to Electromagnetic Radiation	93.
42.	Electromagnetic Spectrum, with Emphasis on Energy Per Photon	100.
43.	Digestive Tract Diagram Including Typical Slow-Wave Frequencies	101.
44.	Limit Cycle Type Waveforms Observed in Human Digestive Tract	102.
45.	Two-Dimensional Coupled Oscillator Structure for Digestive Tract Modelling	103.

*List of Tables*

TABLE	PAGE
1. Exposure Standards for Electromagnetic Radiation	12.
2. Exposure Standards in the United States, Canada, and Western Europe	13.
3. Exposure Standards in the USSR, Poland, and Czechoslovakia	14.
4. Exposure Standards for Electromagnetic Radiation	15.
5. Exposure Standards for Electromagnetic Radiation	16.
6. The Electromagnetic Spectrum, with Emphasis on the Non-ionizing Region	21.
7. Ionization Potentials of Some Elements and Compounds	22.
8. Effects of Various Electric Currents and Current Densities	27.
9. Effects of Electric Currents at Power Line Frequencies	28.
10. Effects of Electromagnetic Radiation at Some Microwave and Higher Frequencies	29.
11. Subjective Effects on Persons Working in Radio Frequency Electromagnetic Fields	30.
12. Clinical Manifestations of Chronic Occupational Exposure of 525 Workers to Electromagnetic Radiation at Microwave Frequencies	31.
13. Clinical and Subjective Effects of Electromagnetic Fields at Power Line Frequencies	32.
14. Effects Cited in PAVE PAWS Report	33.
15. Effects Cited by McCree and Shandala, 1980	34.
16. Effects Cited by Glaser, in Johnson & Shore, Vol. 1, 1976	35.
17. Cardiovascular Disturbances in Persons Chronically Exposed to Electromagnetic Radiation at Various Frequencies	36.
18. Effects Cited by Kleinstein & Dyner, 1980	37.
19. Relation Between Childhood Cancer and Proximity of Residence to Certain 60-Hz Transmission Lines	42.

TABLE	PAGE
20. Occurrence of Some Symptoms in Humans Exposed Occupationally to Electromagnetic Radiation in the Frequency Range 750 kHz-200 MHz	43.
21. Some Characteristics Associated with Microwave Hearing	44.
22. Survey of 1300 Chinese "Microwave Workers"	45.
23. Beneficial Effects Cited by Kleinstein & Dwyer, 1980	53.
24. Profiles of Cases and Modalities of Hyperthermia	54.
25. Reported Hyperthermia Modalities	55.
26. Selected Cancer Statistics and Hyperthermia Considerations	56.
27. Ratio of SAR (Specific Absorption Ratio) to BMR (Basal Metabolic Rate) for an Average Man Exposed to a Plane Wave with a Power Density of 1 mW/cm <sup>2</sup> and 5 mW/cm <sup>2</sup>	71.
28. Dielectric Constant and Conductivity in mmho/cm of Various Body Tissue at 37 Degrees Centigrade	77.
29. Electromagnetic Constants and Related Parameters for Various Tissues	78.
30. Molecular Changes Cited by Taylor, 1979	94.
31. Activation Energy of Molecular Effects in Biological Systems	99.



## Introduction

This is a report of what is known today concerning nonionizing electromagnetic field interactions with the human body. Emphasis here is simultaneously on the two adjectives "nonionizing" and "human", and in that respect the report is probably unique. In the past, while much was being written about certain electromagnetic waves (*e.g.* gamma, X, and cosmic rays) called ionizing radiation, it was generally assumed that others, called NIR (nonionizing radiation), had no effects besides rather obvious ones, which were either avoidable or controllable, such as heating and electric shock. More recently, this assumption has been reconsidered, but the resulting studies are overwhelmingly concerned with the effects of NIR not on humans but on plants, lower animals, and isolated organic substances. A small fraction do concern humans, however. If these human-related studies were collected together, and supplemented by interviews and other sources of information, what new and greater degree of understanding would result? This is the chief question which the report attempts to address.

As part of the answer, many interesting and significant effects and theories were identified. Some relate to the vital issue of health and well being. For example, both theories and observations link nonionizing electromagnetic fields to cancer in humans, in at least three different ways: as a cause, as a means of detection, and as an effective treatment. Other effects are simply curious at this time: audible sounds produced by microwaves (*i.e.* "microwave hearing"); and visible flashes produced by magnetic fields ("magnetophosphenes") at power line frequencies. These are just a small sample of the interactions which will be described in the next two sections of this report (*Adverse, Benign, and Curious Effects* and *Beneficial Effects*).

Perhaps as important as the interactions mentioned above are the theories and effects which are not yet known but probably could be with modest additional effort. Though the human body is complicated, much is known about it, from the macroscopic level to at least the microscopic level of individual protein molecules in cell membranes, and to some extent beyond that. This physiological knowledge, which

is the subject of the fourth section (*Physical and Physiological Foundations*), combined carefully with existing electromagnetic theory could vastly improve the present state of knowledge. This conclusion will be discussed further in the last section (*Some Speculation and Areas for Further Research*).

It is important to further develop the present state of knowledge for at least two very broad reasons. First, as technology improves man's capability for travel and manufacturing, his interactions with electromagnetic fields will increase in both intensity and frequency. In particular:

- Man is encountering new electromagnetic environments as he explores and utilizes regions beyond and beneath the earth's surface where he evolved. He may desire to take some sort of adaptive measures. Figs. 1 and 2 illustrate some features of the terrestrial electromagnetic environment. Fig. 1 shows that there is a quasi-static electric field varying slowly in intensity from 100-250 V/m (volts/meter) over a 12-month period. Fig. 2 shows ELF (extremely low frequency) electric fields. Also shown for comparison are human electroencephalograms. The intent of the comparison is to imply that human functions and the electromagnetic environment are related.
  
- Man is changing his terrestrial electromagnetic environment. Much of the change is a byproduct of industrial processes (*e.g.* welding and heating), communication (radio, television, and other forms of broadcasting), and energy transmission (*e.g.* power lines and the proposed solar power satellite). If he knew the consequences of these changes, he might wish to compensate for or enhance them. Fig. 3 shows the contribution to the environment of some existing manmade sources of electromagnetic fields. Figs. 4 and 5 show the expected contribution from the proposed solar power satellite.

- If he were certain that some interactions are medicinal or otherwise beneficial, man would desire to deliberately alter his electromagnetic environment.

The second broad reason to further develop the present state of knowledge is to eliminate world-wide confusion. This is evidenced by the great disparity among exposure standards promulgated and/or legislated in different nations. Some of these are compared in various ways by Tables 1 through 5 and by Figs. 6 through 8. It is seen that standards differ by as much as three orders of magnitude. The different tables and figures emphasize different parameters of the electromagnetic field as the basis for comparison. Some of them are:

- frequency
- duration of exposure
- field intensity, regardless of power density
- power density, regardless of field intensity
- modulation, electrical (due to waveform) or mechanical (due to rotating antennas)

None of the tables or figures seem to emphasize one essential characteristic of the field, namely, polarization.

As noted at the very beginning of this section, two major restrictions apply to this report. First, interactions are limited to those directly involving humans, in contrast to experimental animals and other organisms. Second, only nonionizing electromagnetic radiation is of interest. These restrictions are not as straight forward as they may seem and merit further discussion.

The first avoids a controversial issue concerning scaling. That is, how can results of animal experiments be extrapolated to humans? Extrapolation is not possible at this time. As an example, researcher Dr. Mary Ellen O'Connor (Dept. of Psychology, University of Tulsa) observed that the drug thalidomide was proven clinically safe using laboratory rats, although the effect on humans was tragic. As

another example, physician Sally Faith Dorfman (Center for Disease Control, Atlanta) noted that aspirin is lethal to laboratory rats. So, extrapolation can fail either way. Apparently beneficial effects can, in fact, turn out to be harmful, and *vice versa*.

The second restriction requires a clear distinction between ionizing radiation and NIR, and actually there is none. Both forms of radiation are electromagnetic waves, and they seem to differ only in terms of frequency. Generally, ionizing radiation is at the high (in frequency) end of the spectrum, while NIR occupies the lower part. What frequency marks the dividing line between ionizing and nonionizing radiation? A standard definition for ionizing radiation was found; however, it is arbitrary and does not identify an abrupt physical threshold. According to that definition, all electromagnetic radiation with energy of 12.4 eV (electron volts) or greater per photon is ionizing. All with lesser energy per photon is not. The formula for the energy per photon of an electromagnetic wave is:

$$E = h\nu \quad (1)$$

where  $h = 6.626 \times 10^{-34}$  joules-sec and  $\nu$  is frequency. So, 12.4 eV is equivalent to about 2,998,000 GHz or a wave length of about 3,000 A (angstroms), which is in the ultraviolet band. (One angstrom is  $10^{-10}$  meters.) Table 6 and Fig. 9 show how this wave length and frequency relate to the rest of the electromagnetic spectrum.

As already noted, the 12.4 eV definition is arbitrary. Readily available data, such as that listed in Table 7, show that many elements can be ionized with lower energy photons. Further, some can be ionized twice with photon energies still less than 12. eV. The table also shows that some compounds can be ionized with photon energies below those required to ionize any of their constituent elements. One familiar example is photo-ionization, which is the basis for photography, and occurs in the visible light band. So, the distinction between ionizing and nonionizing radiation is not precise, at least in terms of frequency and wave length. Based on the data available, however, it seems unlikely, though not impossible, that electromagnetic waves well below about 1,000,000 GHz are ionizing. So,

this report is concerned chiefly with those lower frequencies.

Note that ionization should not be confused with other single photon interactions. The latter are of interest here, and, in principle, they can occur at much lower photon energies, at frequencies below 1,000,000 GHz. These will be discussed briefly in the last section.

One more preliminary technical note will help to clarify the discussions in later sections. This concerns the relationships among electric fields, magnetic fields, power densities, and electric currents. Some effects and theories will be described in terms of one or the other, as though fields, power, and currents are completely independent stimuli. In the human body, however, they are all interdependent. Electric currents and electric fields are related according to the formula,

$$\vec{J} = (j\omega\epsilon + \sigma)\vec{E} \quad (2)$$

where:  $\vec{J}$  = total current density  
 $j = \sqrt{-1}$   
 $\omega = 2\pi \times$  frequency  
 $\epsilon$  = electrical permittivity  
 $\sigma$  = electrical conductivity  
 $\vec{E}$  = electric field.

Magnetic fields are related to electric fields according to Faraday's Law:

$$\nabla \times \vec{E} = -j\omega\mu\vec{H} \quad (3)$$

where  $\mu$  is the magnetic permeability and  $\vec{H}$  is the magnetic field. Finally, the power density  $\vec{S}$  is related to the electric and magnetic fields by the formula,

$$\vec{S} = \frac{1}{2} \vec{E} \times \vec{H}^* \quad (4)$$

So, the effects of one cannot be discussed without implicitly including all of the others. The only possible exception is a static, uni-

form (*i.e.* constant in both time and space) magnetic field, which can exist independently of both an electric field and a current density. This is a highly idealized situation because a human moving about in such a field effectively disrupts the uniformity.

Information for this report was collected from a variety of sources. Written sources (over 1,000 in number) included journals, conference proceedings, technical reports, books, abstracts, and news items. Reportedly, over 5,000 pertinent written documents exist, and it is hoped that the ones examined are a representative sample. Additional sources included in-person meetings, telephone interviews, and lecture tapes. These provided information too recent for distribution in print, and guidance through the extensive literature.

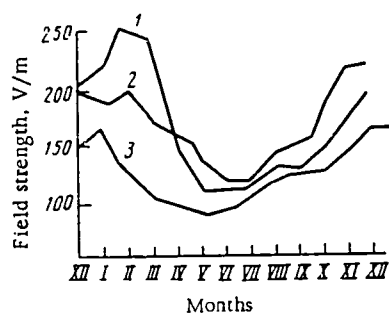

Annual variation of electric field in atmosphere. 1) In Pavlovsk; 2) in Vysokaya Dubrava; 3) in Tashkent.

FIG. 1. ELECTRIC FIELD OCCURRING NATURALLY AT THE SURFACE OF THE EARTH (TAKEN FROM PRESMAN, 1970).

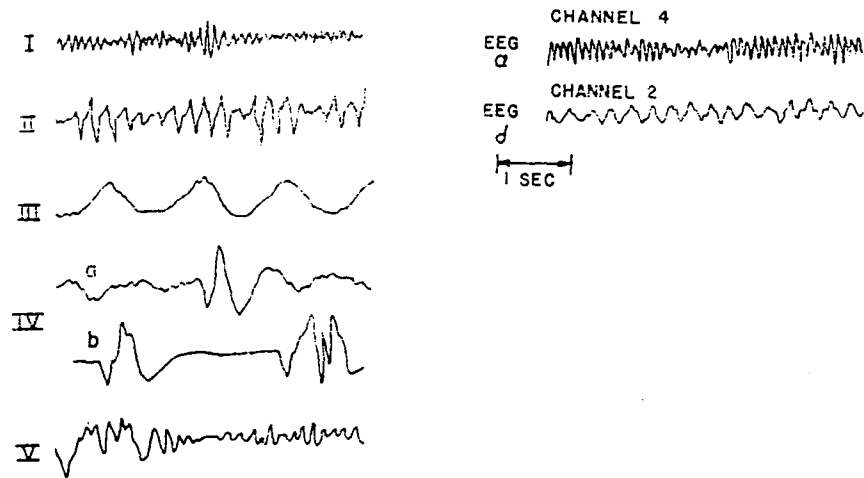

Various types of signals (electric fields) of natural origin in the ELF region.

- I) Electromagnetic waves, Schumann-Resonance;
- II) Local field fluctuations of about 3 Hz;
- III) Local field fluctuations of about 0.7 Hz;
- IV) Field fluctuation as a result of thunderstorm activity:
  - a) Thunderstorm not yet visible on the horizon;
  - b) Thunderstorm on the horizon;
- V) Sunrise appearance of signals. Compare Type I with EEG  $\alpha$  rhythms and Type II with  $\delta$  rhythms.

FIG. 2. SOME NATURALLY OCCURRING LOW FREQUENCY ELECTRIC FIELDS, WITH ELECTROENCEPHALOGRAMS FOR COMPARISON (FROM KONIG, IN PERSINGER, 1974).



Average background levels of RF/MW radiation.

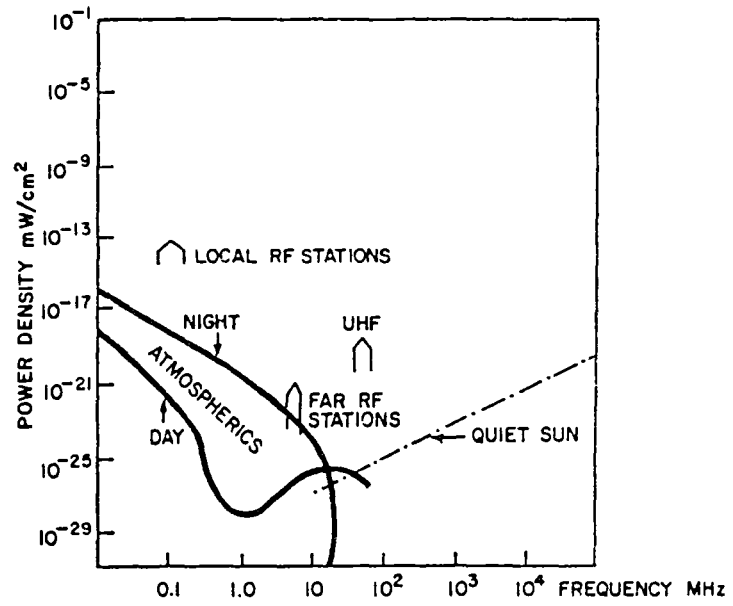

FIG. 3. SOME NATURAL AND MANMADE SOURCES OF ELECTROMAGNETIC RADIATION (FROM DWYER & LEEPER, 1978).

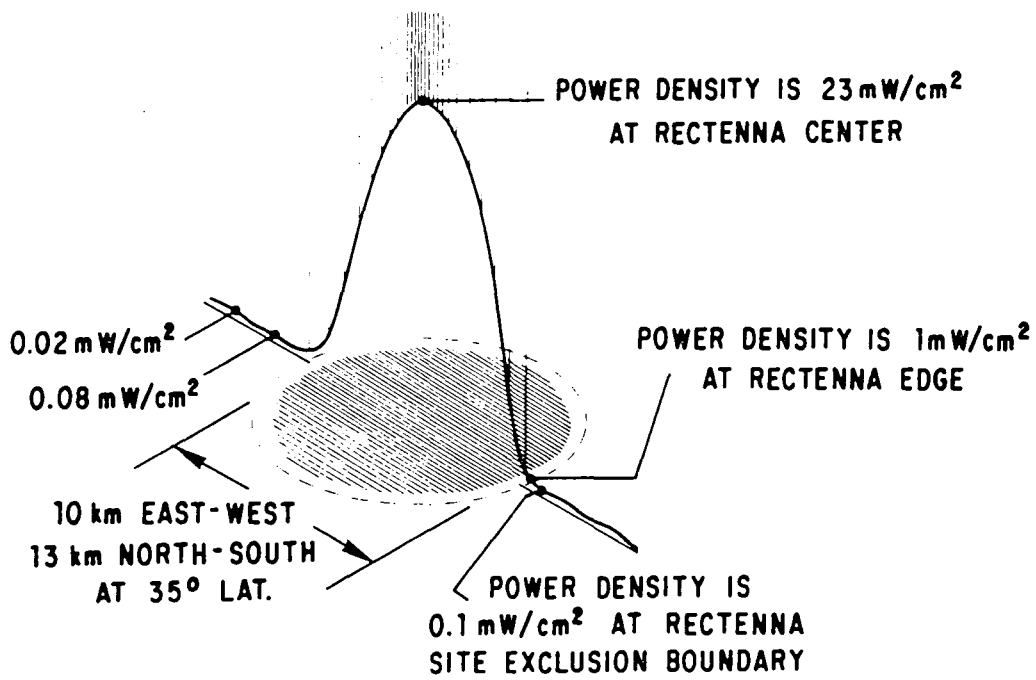
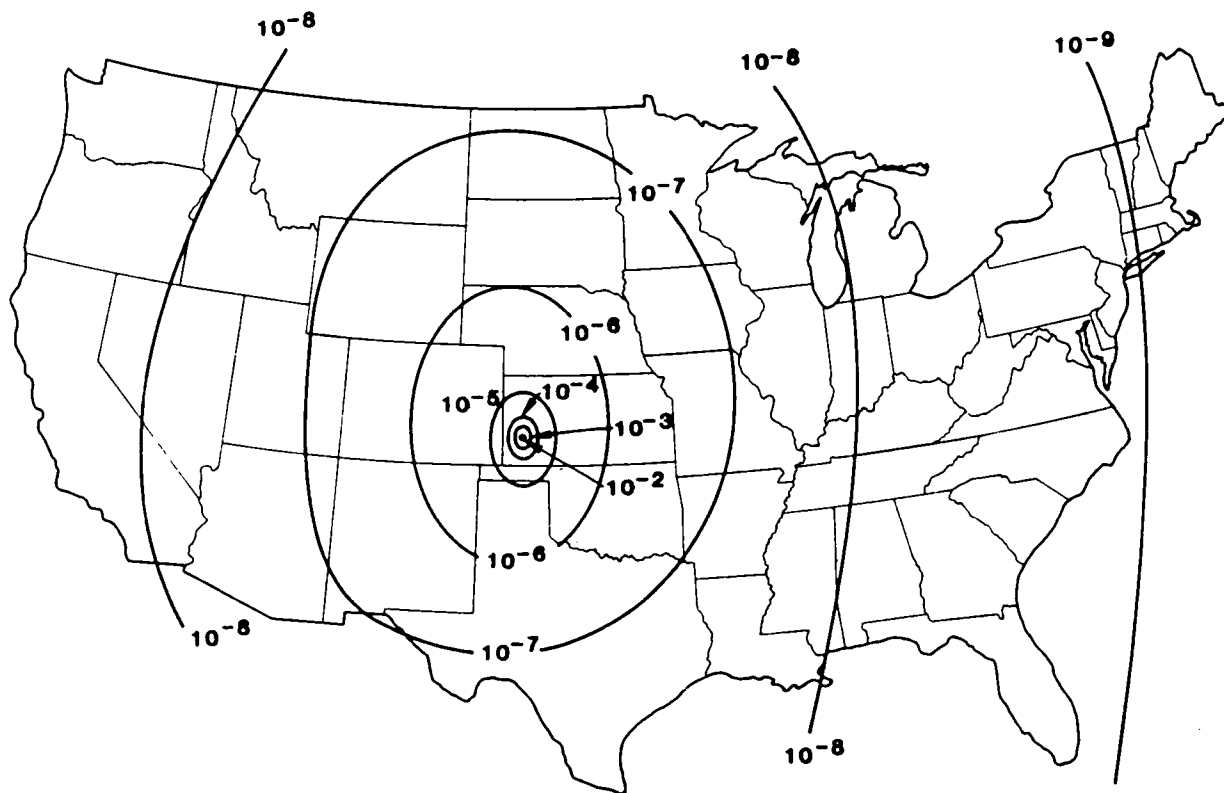

FIG. 4. INCIDENT ELECTROMAGNETIC RADIATION FROM THE PROPOSED SOLAR POWER SATELLITE (FROM VALENTINO, 1980).



Power Density Distribution ( $\text{mW}/\text{cm}^2$ ) for a Single Hypothetical Rectenna Site

FIG. 5. INCIDENT ELECTROMAGNETIC RADIATION FROM THE PROPOSED SOLAR POWER SATELLITE, AT DISTANCES FAR FROM THE RECEIVER (FROM VALENTINO, 1980).

	Occupational	Frequency	Exposure Duration	Public
Canada <sup>1</sup> (Proposed)	5 mW/cm <sup>2</sup>	(1 - 300 GHz)	No limit	1 mW/cm <sup>2</sup>
Czechoslovakia	0.01 mW/cm <sup>2</sup>	(0.3 - 300 GHz)	8 hours	0.001 mW/cm <sup>2</sup>
Poland	0.2 mW/cm <sup>2</sup>	(0.3 - 300 GHz)	10 hours	0.01 mW/cm <sup>2</sup>
Sweden	1 mW/cm <sup>2</sup>	(0.3 - 300 GHz)	8 hours	None
U.S. <sup>2</sup>	10 mW/cm <sup>2</sup>	(0.01 - 100 GHz)	No limit	None
U.S.S.R.	0.01 mW/cm <sup>2</sup>	(0.3 - 300 GHz)	Entire workshift	0.001 mW/cm <sup>2</sup>

1. Canada is also proposing a 1 mW/cm<sup>2</sup> exposure limit at 10 MHz - 1 GHz Frequency.
2. Also with slight modification is the United Kingdom, German Federal Republic, Netherlands, and France. A new RFEM exposure guideline is being proposed by the American National Standards Institute (ANSI) that would cover the general population in the United States.

TABLE 1. EXPOSURE STANDARDS FOR ELECTROMAGNETIC RADIATION (FROM DAVID, 1980).

Standard	Type	Frequency	Exposure limit	Exposure duration	CW/ pulsed	Antenna Stationary/ Rotating	Remarks
U.S. ANSI 1974 (305)	Occupational	10 MHz - 100 GHz	10 mW/cm <sup>2</sup> 200 V/m 0.5 A/m	no limit	CW	both	
			1 mWhr/cm <sup>2</sup>	0.1 hour	pulsed	both	
U.S. Army and Air Force 1965 (292)	Occupational	10 MHz - 300 GHz	10 mW/cm <sup>2</sup>	no limit	both	both	
			10-100 mW/cm <sup>2</sup>	6000/X <sup>2</sup> (min.)	both	both	X-power density in mW/cm <sup>2</sup>
U.S. Indust. Hygienist 1971 (306)	Occupational	100 MHz - 100 GHz	10 mW/cm <sup>2</sup>	8 hours	both	both	
			25 mW/cm <sup>2</sup>	10 min.	both	both	
Canada Can. Stan- dards Assoc. 1966 (307)	Occupational	10 MHz - 100 GHz	10 mW/cm <sup>2</sup>	no limit	CW	both	
			1 mWhr/cm <sup>2</sup>	0.1 hour	pulsed	both	
Canada H&W proposed (301, 313)	Occupational	10 MHz - 1 GHz	1 mW/cm <sup>2</sup>	no limit	both	both	
		1-300 GHz	5 mW/cm <sup>2</sup>	no limit	both	both	
		10 MHz - 300 GHz	25 mW/cm <sup>2</sup>	1 min.	both	both	
	General public	10 MHz - 300 GHz	1 mW/cm <sup>2</sup>	no limit	both	both	
Sweden Worker Prot. Authority 1976 (308)	Occupational	0.3-300 GHz	1 mW/cm <sup>2</sup>	8 hours	both	both	
		10-300 MHz	5 mW/cm <sup>2</sup>	8 hours	both	both	
		0.3-300 GHz	1-25 mW/cm <sup>2</sup>	60/X (min.)	both	both	X-power density in mW/m <sup>2</sup>
		10 MHz - 300 GHz	25 mW/cm <sup>2</sup>	any	CW, pulsed averaged over 1 sec.	both	

TABLE 2. EXPOSURE STANDARDS IN THE UNITED STATES, CANADA, AND WESTERN EUROPE (FROM STUCHLY, 1978).

Standard	Type	Frequency	Exposure limit	Exposure duration	CW/ pulsed	Antenna Stationary/ Rotating	Remarks	
USSR Government 1977 (299)	Occupational	10-30 MHz	20 V/m	working day	both	both	Military units and establishments of the Ministry of Defence excluded	
		30-50 MHz	10 V/m	working day	both	both		
			0.3 A/m	working day	both	both		
		50-300 MHz	5 V/m	working day	both	both		
		0.3-300 GHz	10 $\mu\text{W}/\text{cm}^2$	working day	both	stationary		
			100 $\mu\text{W}/\text{cm}^2$	working day	both	rotating		
			100 $\mu\text{W}/\text{cm}^2$	2 hours	both	stationary		
			1 $\text{mW}/\text{cm}^2$	2 hours	both	rotating		
1 $\text{mW}/\text{cm}^2$	20 min.	both	stationary					
USSR Government 1970 (42)	General public	0.3-300 GHz	1 $\mu\text{W}/\text{cm}^2$	24 hours	both	both		
Czechoslovakia Government 1970 (42)	Occupational	10-30 MHz	50 V/m	working day	both	both		
		30-300 MHz	10 V/m	working day	both	both		
		0.3-300 GMz	25 $\mu\text{W}/\text{cm}^2$	working day	cw	both		
			10 $\mu\text{W}/\text{cm}^2$	working day	pulsed	both	max peak 1 $\text{kW}/\text{cm}^2$	
			1.6 $\text{mW}/\text{cm}^2$	1 hour	cw	both		
	0.64 $\text{mW}/\text{cm}^2$	1 hour	pulsed	both				
	General public	30-300 MHz	1 V/m	24 hours	both	both		
		0.3-300 GMz	2.5 $\mu\text{W}/\text{cm}^2$	24 hours	cw	both		
			1 $\mu\text{W}/\text{cm}^2$	24 hours	pulsed	both		
		30-300 MHz	1 V/m	24 hours	both	both		
10-30 MHz		2.5 V/m	24 hours	both	both			
Poland Government 1972 (42, 300)	Occupational	0.3-300 GHz	0.2 $\text{mW}/\text{cm}^2$	10 hours	both	stationary		
			0.2-10 $\text{mW}/\text{cm}^2$	$32/P^2$ (hours)	both	stationary	P-power density in $\text{W}/\text{m}^2$	
			1 $\text{mW}/\text{cm}^2$	10 hours	both	rotating		
			1-10 $\text{mW}/\text{cm}^2$	$800/P^2$ (hours)	both	rotating	P-power density in $\text{W}/\text{m}^2$	
	General public	0.3-300 GHz	10 $\mu\text{W}/\text{cm}^2$	24 hours	both	stationary		
			0.1 $\text{mW}/\text{cm}^2$	24 hours	both	rotating		
Poland Government 1975 proposed (42, 300)	Occupational	10-300 MHz	20 V/m	working day	both	both		
			20-300 V/m	$3200/E^2$ (hours)	both	both	E-electric field intensity in V/m	
	General public	10-300 MHz	7 V/m	24 hours	both	both		

TABLE 3. EXPOSURE STANDARDS IN THE USSR, POLAND, AND CZECHOSLOVAKIA (FROM STUCHLY, 1978).

Country, author	Frequency (MHz)	Maximum permissible intensity	Remarks
USA: Ely, T.S., Goldman, D. (1957)	3000	100 mW/cm <sup>2</sup> 150 mW/cm <sup>2</sup> 5 mW/cm <sup>2</sup>	Whole body Eyes Testes
USA: U.S. Army (1958)	All	10 mW/cm <sup>2</sup>	-
USA: Schwan, H.P. and Li, K. (1956)	1000 1000-3000 3000	30 mW/cm <sup>2</sup> 10 mW/cm <sup>2</sup> 20 mW/cm <sup>2</sup>	Whole body Whole body Whole body
USA: General Electric	700	1 mW/cm <sup>2</sup>	-
USA: Bell Tele- phone Labs. (1956)	750-30 000	1 mW/cm <sup>2</sup>	-
USA: Mumford, W.W. (1956)	-	0.1 mW/cm <sup>2</sup>	-
NATO (1956)	-	0.5 mW/cm <sup>2</sup>	-
Sweden	87	222 V/m	-
	87	25 V/m	-
Britain	300	0.01 mW/cm <sup>2</sup>	-
West Germany (1962)	-	10 mW/cm <sup>2</sup>	
USSR (1965)	0.1-1.5	20 V/m 5 A/m	
	1.5-30	20 V/m	
	30-300	5 V/m	
	> 300	0.01 mW/cm <sup>2</sup> 0.1 mW/cm <sup>2</sup> 1 mW/cm <sup>2</sup>	6 hr daily 2 hr daily 15 min daily
Poland (1961)	> 300	0.01 mW/cm <sup>2</sup> 0.1 mW/cm <sup>2</sup> 1 mW/cm <sup>2</sup>	Entire workday 2-3 hr daily 15-20 min daily
Czechoslovakia (1965)	> 300	0.025 mW/cm <sup>2</sup> 0.01 mW/cm <sup>2</sup>	Cw operation } 8*hr Pulsed op'n } daily
	0.01-300	10 V/m	
USA (1966)	10-100 000	1 (mW/cm <sup>2</sup> )hr	Every 6 min
Canada (1966)	10-100 000	1 (mW/cm <sup>2</sup> )hr	Every 6 min

\*For shorter exposure, see Figs. 39 and 40. (See also Appendix.)

TABLE 4. EXPOSURE STANDARDS FOR ELECTROMAGNETIC RADIATION (FROM MARHA & TUHA, 1971).

Country, and Type of Standard	Radiation Frequency and Waveform	Maximum Levels	Comments and Conditions
USA (ANSI) Exposure Standard	10 MHz - 100 GHz (all waveforms)	10 mW/cm <sup>2</sup>	For periods of 0.1 hr or more. Whole and partial body. Reduction in high temperature environments, or for health reasons recommended.
U.S. Army/ Air Force		1 mW.h/cm <sup>2</sup> 10 mW/cm <sup>2</sup>	Averaged over any 0.1 hr period. Continuous exposure. When power density (S) is in the 10-100 mW/cm <sup>2</sup> range, max allowed exposure time is 6000/W <sup>2</sup> minutes, where S is expressed in mW/cm <sup>2</sup> .
USSR 1976 Industrial Safety Exposure Standard*		100 mW/cm <sup>2</sup> 0.1 - 1 mW/cm <sup>2</sup>	No occupancy or protective clothing required. For a 20 min maximum exposure duration. Standard states: "Protective goggles mandatory. Power density must not then exceed 0.1 mW/cm <sup>2</sup> for balance of work day". Radiation from adjustable or scanning antennae is allowed at this level for 2 hrs.
		10 - 100 μW/cm <sup>2</sup> 10 μW/cm <sup>2</sup>	For a 2 hrs maximum duration (then 10 μW/cm <sup>2</sup> for balance of work day). Required limit for a 'work day', all sources, except adjustable or scanning antennae (100 μW/cm <sup>2</sup> ).
	50 MHz - 300 MHz (all waveforms)	5 V/m	Levels in "work areas and other areas where personnel are permitted and occupationally exposed" . . . shall not, in the course of the work day, exceed this value.
	30 - 50 MHz	10 V/m (or 0.3A/m)	Whichever is the greater.
	3 - 30 MHz	20 V/m	
	60 kHz - 3 MHz	50 V/m	(or 5 A/m in the range 60 kHz to 1.5 MHz)
Czech. Soc. Rep. Exposure Standard	300 MHz - 300 GHz	25 μW/cm <sup>2</sup>	8 hrs/day, for CW waveforms; reduced to 10 μW/cm <sup>2</sup> for pulsed waveforms.
USA: Product Emission Standard	0.01 - 300 MHz 890 - 6000 MHz	10 V/m 1 - 5 mW/cm <sup>2</sup>	8 hrs/day Emitted by the product at full power operation; lower level when manufactured ("prior to acquisition").
	(ISM Bands in this range)		5 mW/cm <sup>2</sup> max in use. Measured with specified load (275 ± 15 ml H <sub>2</sub> O at 20 ± 5 °C), at full power, 5 cm or more from any external surfaces by an approved instrument with effective aperture < 25 cm <sup>2</sup> , no dimension > 10 cm.
Canada: Product Emission Standard	0.01 - 300 GHz	1 mW/cm <sup>2</sup>	Emitted by product at maximum output, at points "at least 5 cm from the external surface of the oven", when the oven is loaded with a load equal to the water equivalent of the minimum operating load, as specified by the manufacturer, at 20 ± 5 °C. Instrument specified in standard.
		5 mW/cm <sup>2</sup>	Emission at no load, if total microwave output is < 3 kW.
Canada: Recommended Exposure Limit	0.01 - 300 GHz	1 mW/cm <sup>2</sup>	Average power density limit in any 1 hr period (max 25 mW/cm <sup>2</sup> averaged over 1 min).

\*The reader is referred to the actual standards for more detail. Great caution is required in interpreting and translating standards.

TABLE 5. EXPOSURE STANDARDS FOR ELECTROMAGNETIC RADIATION.



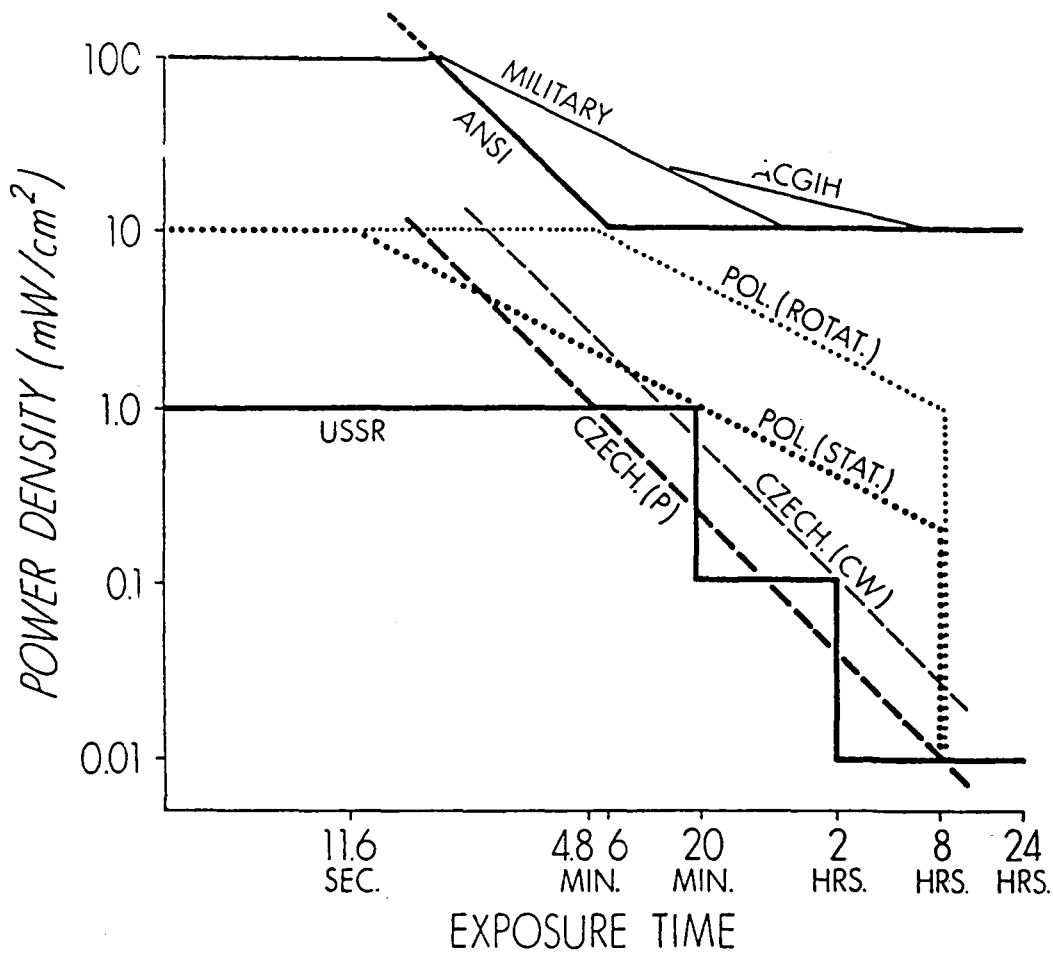

FIG. 6. EXPOSURE STANDARDS FOR ELECTROMAGNETIC RADIATION, WITH EMPHASIS ON DURATION OF EXPOSURE (FROM JOHNSON & SHORE, 1975).

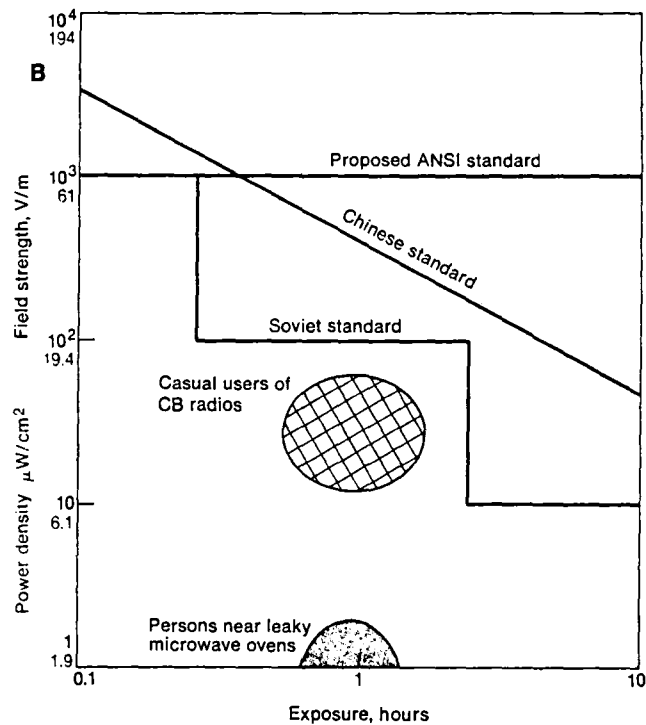
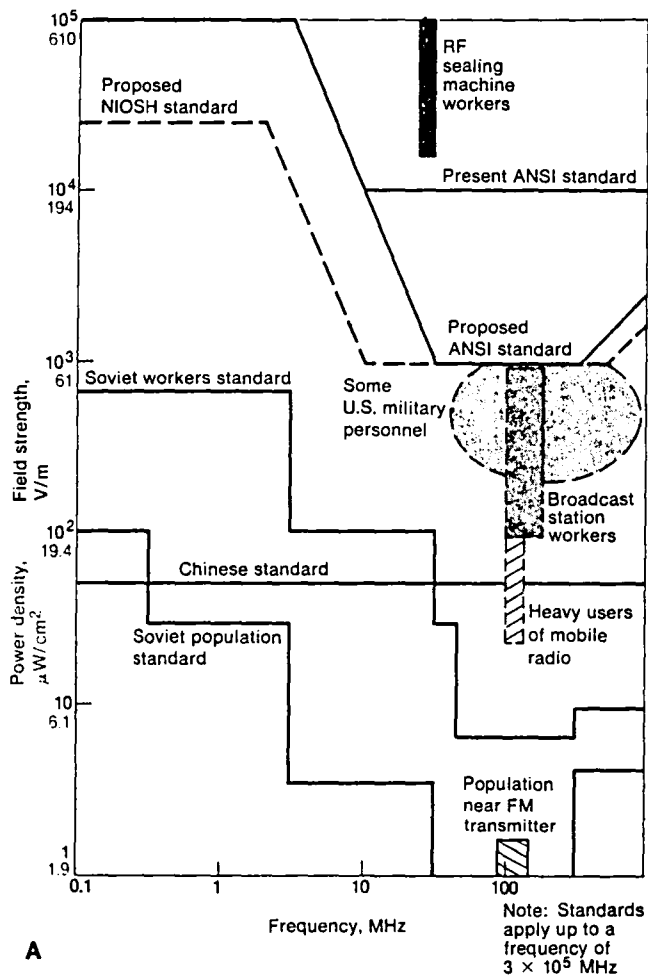

FIG. 7. EXPOSURE STANDARDS FOR ELECTROMAGNETIC RADIATION, WITH EMPHASIS ON FREQUENCY AND DURATION OF EXPOSURE (FROM LERNER, 1980).

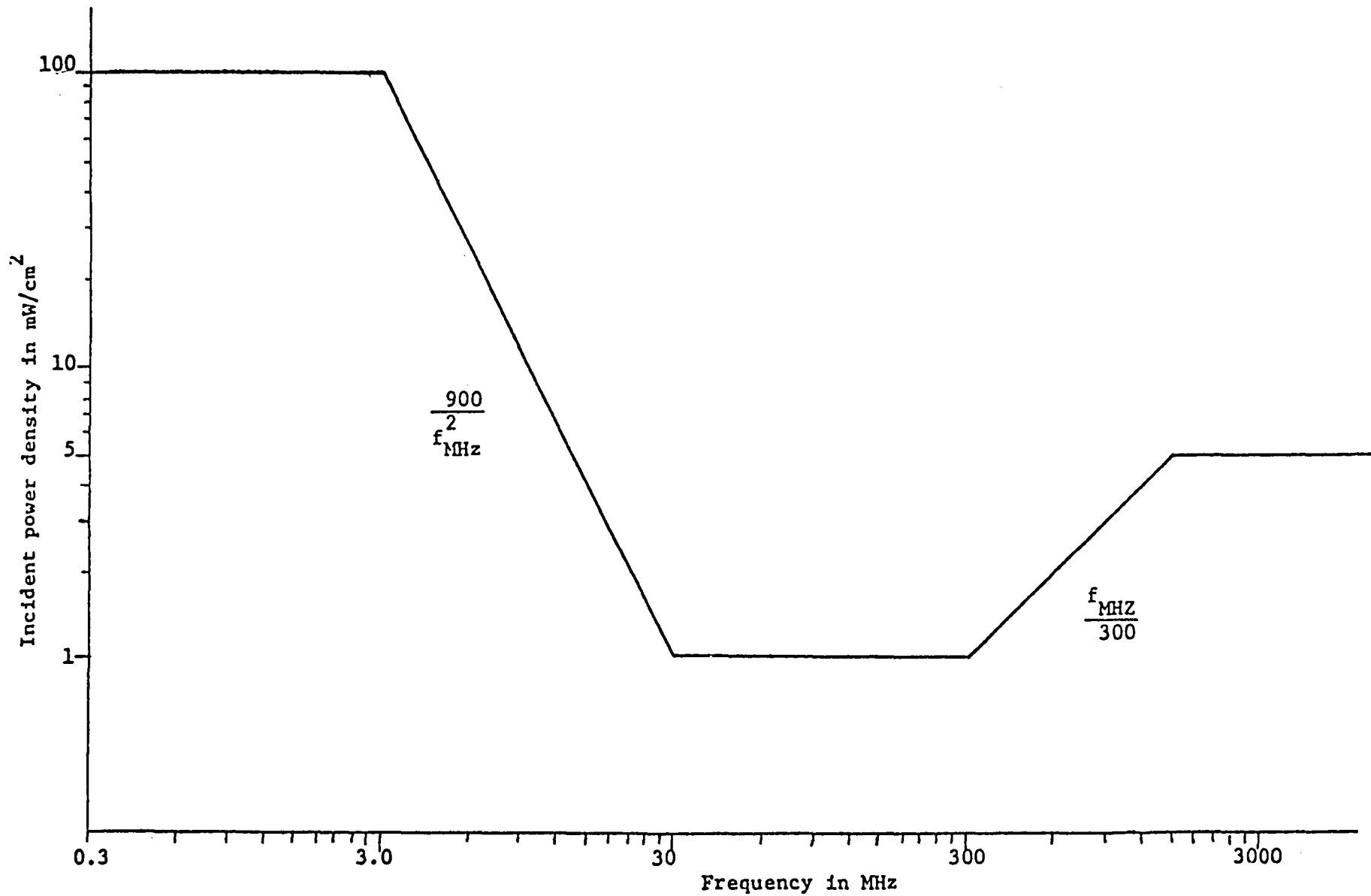

FIG. 8. AMERICAN NATIONAL STANDARDS INSTITUTE PROPOSED EXPOSURE STANDARD FOR ELECTROMAGNETIC RADIATION.

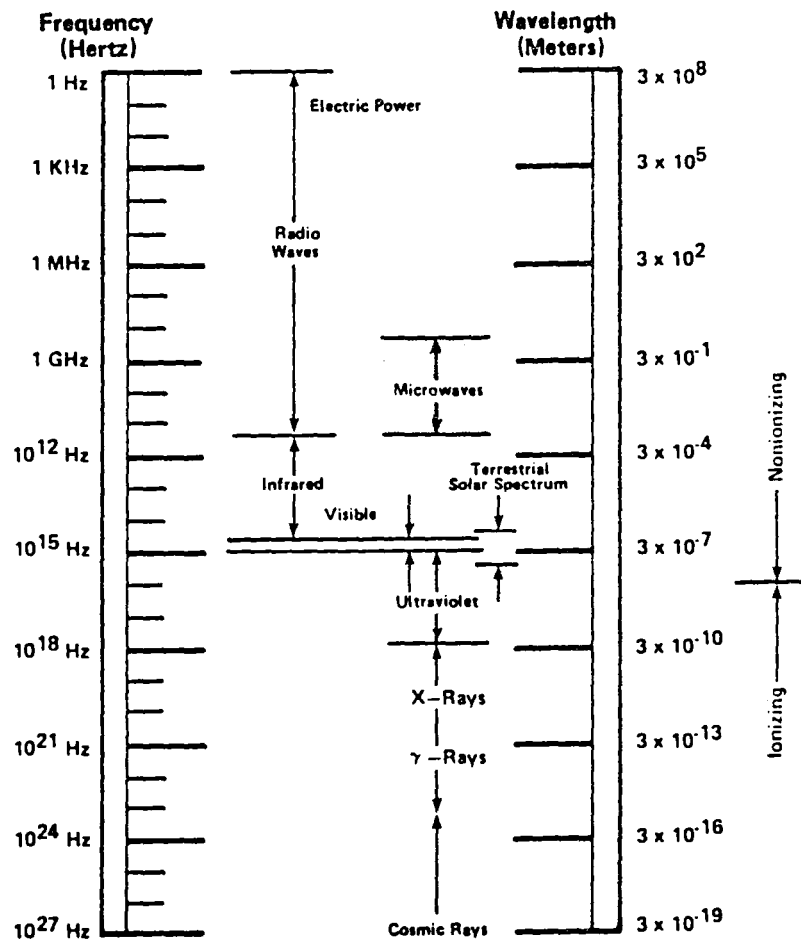

FIG. 9. THE ELECTROMAGNETIC SPECTRUM, SHOWING IONIZING AND NON-IONIZING REGIONS (FROM DAVID, 1980).

Type of Radiation	Energy Range	Frequency Range	Wavelength Range
Ionizing	above 12.4 eV	above 3,000 THz	below 100 nm
Ultraviolet	6.15-3.08 eV	1,500-750 THz	200-400 nm
Visible	3.08-1.76 eV	750-428 THz	400-700 nm
Infrared	1.76 eV-1.24 meV	428 THz-300 GHz	700 nm-1 mm
Microwaves	1.2 meV-1.2 $\mu$ eV	300 GHz-300 MHz	1 mm - 1 m
EHF	1.2 meV-100 $\mu$ eV	300-30 GHz	1 mm - 10 mm
SHF	100 $\mu$ eV-12 $\mu$ eV	30-3 GHz	10 mm - 100 mm
UHF	12 $\mu$ eV-1.2 $\mu$ eV	3 GHz-300 MHz	100 mm - 1 m
Radar	200 $\mu$ eV-900 neV	56 GHz-220 MHz	5.4 mm - 1.3 m
Radiofrequency	1.2 $\mu$ eV-1.2 neV	300 MHz-300 KHz	1 m - 1 km

TABLE 6. THE ELECTROMAGNETIC SPECTRUM, WITH EMPHASIS ON THE NONIONIZING REGION (FROM DWYER, 1978).

## IONIZATION POTENTIALS OF THE ELEMENTS

Different methods have been employed to measure ionization potentials. Abbreviations of the methods used for data listed in the following table are:

S: Vacuum ultraviolet spectroscopy  
SI: Surface ionization, mass spectrometric  
EI: Electron impact with mass analysis

El.	At. No.	Ionization potential in volts								Meth.
		I	II	III	IV	V	VI	VII	VIII	
Ar	18	15.755	27.62	40.9	59.79	75	91.3	124	143.46	S
Ac	89	6.9	12.1	20						S
Ag	47	7.574	21.48	34.82						S
Al	13	5.984	18.823	28.44	119.96	153.77	190.42	241.38	284.53	S
As	33	9.81	18.63	28.34	50.1	62.6	127.5			S
At	85	9.5								S
Au	79	9.22	20.5							S
B	5	8.296	25.149	37.92	259.298	340.127				S
Ba	56	5.21	10.001	35.5						S
Be	4	9.32	18.206	153.85	217.657					S
Bi	83	7.287	16.68	25.56	45.3	56	88.3			S
Br	35	11.84	21.6	35.9	47.3	59.7	88.6	103	193	S
C	6	11.256	24.376	47.871	64.476	391.986	489.84			S
Ca	20	6.111	11.868	51.21	67	84.39	109	128	143.3	S
Cb(Nb)	41	6.88	14.32	25.04	38.3	50	103	125		S
Cd	48	8.991	16.904	37.47						S
Ce	58	5.6	12.3	20	33.3					SI
Cl	17	13.01	23.8	39.9	53.5	67.8	96.7	114.27	348.3	S
Co	27	7.86	17.05	33.49	83.1					S
Cr	24	6.764	16.49	30.95	50	73	91	161	185	S
Cs	55	3.893	25.1	35						S
Cu	29	7.724	20.29	36.83						S
Dy	66	6.8								S
Er	68	6.08								SI
F	9	17.418	34.98	62.646	87.14	114.214	157.117	185.139	953.6	S
Fe	26	7.87	16.18	30.643	56.8				151	S
Fr	87	4								S
Ga	31	6	20.57	30.7	64.2					S
Gd	64	6.16	12							S
Ge	32	7.88	15.93	34.21	44.7	93.4				S
H	1	13.595								S
He	2	24.481	54.403							S
Hf	72	7	14.9	23.2	33.3					S
Hg	80	10.43	18.751	34.2	49.5**		67**			S
I	53	10.454	19.13						170	S
In	49	5.785	18.86	28.03	54.4					S
Ir	77	9								S
K	19	4.339	31.81	46	60.9	82.6	99.7	118	155	S
Kr	36	13.996	24.56	36.9	43.5**	63**	94**			S
La	57	5.61	11.43	19.17						S
Li	3	5.39	75.619	122.419						S
Lu	71		14.7							S
Mg	12	7.644	15.031	80.14	109.29	141.23	186.49	224.9	265.957	S
Mn	25	7.432	15.636	33.69	52	76		119	196	S
Mo	42	7.10	16.15	27.13	46.4	61.2	68	126	153	S
N	7	14.53	29.593	47.426	77.45	97.863	551.925	666.83		S
Na	11	5.138	47.29	71.715	98.88	138.37	172.09	208.444	264.155	S
Nb(Cb)	41	6.88	14.32	25.04	38.3	50	103	125		S
Nd	60	5.51								SI
Ne	10	21.559	41.07	63.5	97.02	126.3	157.91			S
Ni	28	7.633	18.15	35.16						S
O	8	13.614	35.108	54.886	77.394	113.873	138.08	739.114	871.12	S
Os	76	8.5	17							S
P	15	10.484	19.72	30.156	51.354	65.007	220.414	263.31	309.26	S
Pb	82	7.415	15.029	31.93	42.31	68.8				S
Pd	46	8.33	19.42	32.92						S
Po	84	8.43								S
Pr	59	5.46								SI
Pt	78	9.0	18.56							S
Pu	94	5.1								S
Ra	88	5.277	10.144							S
Rb	37	4.176	27.5	40						S
Re	75	7.87	16.6							S
Rh	45	7.46	18.07	31.05						S
Rn	86	10.746								S
Ru	44	7.364	16.76	28.46						S
S	16	10.357	23.4	35	47.29	72.5	88.029	280.99	328.8	S
Sb	51	8.639	16.5	25.3	44.1	56	108			S
Sc	21	6.54	12.8	24.75	73.9	92	111	139	159	S
Se	34	9.75	21.5	32	43	68	82	155		S
Si	14	8.149	16.34	33.488	45.13	166.73	205.11	246.41	303.07	S
Sm	62	5.6	11.2							S
Sn	50	7.342	14.628	30.49	40.72	72.3				S
Sr	38	5.692	11.027		57					S
Ta	73	7.88	16.2							S
Tb	65	5.98								S
Tc	43	7.28	15.26	29.54						S
Te	52	9.01	18.6	31	38	60	72	12.7		S
Th	90	6.95			29.38					S
Ti	22	6.82	13.57	27.47	43.24	99.8	120	141	172	S
Tl	81	6.106	20.42	29.8	50.7					S
Tm	69	5.81								S
U	92	6.08								S
V	23	6.74	14.65	29.31	48	65	129	151	170	S
W	74	7.98	17.7							S
Xe	54	12.127*	21.2	31.3	42	53	58	135		SI
Y	39	6.38	12.23	20.5		77				S
Yb	70	6.2	12.10							S
Zn	30	9.391	17.96	39.7						S
Zr	40	6.84	13.13	22.98	34.33		99			S

\*These steps by S method.

\*\*These steps by EI method.

## IONIZATION POTENTIALS

### COMPOUNDS

The first ionization potential of the molecules indicated is given in volts.

Compound	Ionization potential I volts	Compound	Ionization potential I volts
Br <sub>2</sub>	12.8	F <sub>2</sub>	17.8 (calc.)
BrCl	12.9 (calc.)	H <sub>2</sub>	15.6
C <sub>2</sub>	12	HBr	13.2
CH <sub>2</sub> O, formaldehyde	11.3	HCl	14.8
CH <sub>3</sub> Br, methyl bromide	10.0	HCN	13.8
CH <sub>2</sub> Cl, methyl chloride	10.7	HF	17.7 (calc.)
CH <sub>3</sub> I, methyl iodide	9.1	HI	12.8
CH <sub>4</sub> , methane	14.5	H <sub>2</sub> O	12.56
CO	14	H <sub>2</sub> S	10.42
CO <sub>2</sub>	14.1	I <sub>2</sub>	9.7
CO <sub>2</sub>	14.4	IBr	11.6 (calc.)
CS <sub>2</sub>	10.6	ICl	11.9 (calc.)
CS <sub>2</sub>	10.4	N <sub>2</sub>	15.51
C <sub>2</sub> H <sub>2</sub> , acetylene	11.6	NH <sub>3</sub>	11.2
C <sub>2</sub> H <sub>4</sub> , ethylene	12.2	NO	9.5
C <sub>2</sub> H <sub>6</sub> , ethane	12.8	NO <sub>2</sub>	11.0
C <sub>6</sub> H <sub>6</sub> , benzene	9.6	N <sub>2</sub> O	12.9
C <sub>7</sub> H <sub>8</sub> , toluene	8.5	O <sub>2</sub>	12.5
Cl <sub>2</sub>	13.2	S <sub>2</sub>	10.7
		SO <sub>2</sub>	13.1

TABLE 7. IONIZATION POTENTIALS OF SOME ELEMENTS AND COMPOUNDS (FROM THE CRC HANDBOOK OF CHEMISTRY AND PHYSICS).

## Adverse, Benign, and Curious Effects

The effects listed and/or discussed in this section relate to at least three of the five senses (touch, hearing, and sight) and nearly every system of the human body (including circulatory, digestive, nervous, and muscular). Many of them are temporary; however, some result in death and persistent disease. Some are better understood and more widely accepted than others.

Despite an exhaustive search of the literature and information from other sources, this section may appear to be sketchy and loosely organized. Some effects have been explored only qualitatively, and such seemingly essential information as frequency, polarization, intensity, and duration of exposure may not be precisely described, as well as the effect itself. This state of affairs seems typical of a new area of investigation for which neither the electromagnetic variables nor biological endpoints are yet clear. This uncertainty has resulted in nonuniform reporting, variable rigor, and inadequately planned research. Still, it does not necessarily mean the effects reported are not real. It most surely means that a stronger theoretical foundation is required to positively identify, quantify, and otherwise understand them.

Nonetheless, some effort has been made to organize the information in this section. The presentation proceeds roughly from the general to the specific. Described first are overall results inferred from many different experimental, epidemiological, clinical, and other type studies. Next, the results from individual reports are tabulated. Then, at the most specific level, original illustrations and charts from individual reports are reproduced. Finally, at the end of the section is a recapitulation of results.

### *Overall Results*

Tables 8 through 10 show some of the widely acknowledged effects and the electromagnetic fields and currents required to produce them. Only a few frequency ranges are represented in these tables; however, the most extreme adverse effect, death (by ventricular fibrillation) is included.

Tables 11 and 12 list some of the more controversial effects. The frequency ranges and exposure levels are not described exactly, though some individual reports mentioned later in this section are more precise about those parameters. This lack of precision, and the subsequent controversy surrounding the results, are chief disadvantages of restricting attention to humans. After an adverse effect is diagnosed, perhaps after years of growing discomfort, it may be difficult to isolate the conditions exclusively responsible from the general complexity of the subject's occupational and living routines. For example, a "microwave worker" might service a great variety of radars and radio transmitters, each with different frequencies, exposure levels, etc. Without a solid theoretical foundation to use as a guide, the most suspect source of electromagnetic radiation cannot be identified.

Of these controversial effects, the ones associated with the central nervous system are collectively termed "neurasthenia". Some of these are reportedly reversible. That is, when the electromagnetic field vanishes, so do the effects.

#### *Results From Individual Reports*

Tables 13 through 18 summarize various individual reports and studies, and in some cases provide more specific information concerning frequency, exposure level, and other essential parameters. Table 13 concerns power line frequencies (50-60 Hz) exclusively. Tables 14 through 17 concern the frequency bands most often associated with communication and radar. The researchers listed in these tables are exclusively Eastern European. Table 18 covers many frequency bands from ELF (0-300 Hz) through SHF (3-30 GHz), and includes reports from outside Eastern Europe.

Table 18 contains some especially unusual entries. First, there is a report by Eckert of the most extreme adverse effect, death (by sudden infant death syndrome). Second, there is a report from the United States by Bise concerning neurasthenic effects previously reported exclusively from Eastern Europe. Also, an Italian report by Alberti concerns neurasthenic effects. Third, an extreme adverse effect, promotion of cancer, is reported from Australia by Holt.



## *Original Data Displays From Individual Reports*

The remaining tables and figures are taken from individual studies. They are included not only for their informational content, but also as examples of how original data are encountered during the preparation of a report such as this one.

Figs. 10 through 13 concern effects in the ELF band. Fig. 10 attempts to correlate quasi-static magnetic fields with the most extreme adverse effect, death. Figs. 11 and 12, due to Konig, are unusual because they result from controlled experiments. They show that 3 Hz electric fields increase reaction time and galvanic skin response. Similarly, Fig. 13, due to Wever, results from controlled experiments. They show that removal of the earth's natural electric field and/or the application of a manmade field can disrupt circadian rhythm.

Table 19, taken from Wertheimer and Leeper, is unusual for at least two reasons. First, it is an epidemiological study. Second, it concerns an extreme adverse effect (childhood cancer).

Tables 20 through 22 and Figs. 14 through 17 concern effects in the frequency bands most often associated with communication and radar. Of these, Table 22 concerns an especially curious effect, microwave hearing. Evidently, pulsed microwaves produce click like audio sensations.

## *Recapitulation*

From all of the tables and figures in this section, it is seen that electromagnetic fields may cause death in at least two ways, ventricular fibrillation and sudden infant death syndrome. Both of these occur at power line frequencies; however, one technical newsletter (*Bioelectromagnetic Society Newsletter*, December, 1980) reported one fatality associated with much higher frequencies. Death followed accelerated aging, and a New York State court was convinced that protracted exposure to microwaves was the cause.

It is also seen from the tables and figures that electromagnetic

fields may promote cancer. Holt (Table 18) reported the stimulation of human cancers at VHF (30-300 MHz) frequencies and exposure levels less than  $10 \text{ mW/cm}^2$  (milliwatts per square centimeter). Wertheimer and Leeper (Table 19) performed a formal epidemiological study relating childhood cancer to fields at 60 Hz.

At least one adverse effect is not included in the tables and figures, and that is cataracts. Over fifty have been attributed to exposure at microwave frequencies (roughly 3-300 GHz). One ophthalmologist claims these cataracts can be uniquely identified by clouding of the posterior part of the lens, in contrast to clouding of the anterior part in other cases.

With respect to curious effects, at least two have been included in this section, microwave hearing and visual effects. The former has already been discussed in connection with Table 22. Visual effects include the distortion of thresholds for various colors (Table 15) and magnetophosphenes (Table 18). The latter effect is the perception of light flashes in response to a magnetic field.

Cardiology	0.03 - 10 mA/cm <sup>2</sup>
Electrosleep and Electrical Anaesthesia	10 - 100 mA (0.1 - 1 mA/cm <sup>2</sup> )
Electro-Hazards:	
Sensation	1 mA
"Let Go"	10 mA
Fibrillation	100 mA
Biophysics and Axonology	1 mA/cm <sup>2</sup>

TABLE 8. EFFECTS OF VARIOUS ELECTRIC CURRENTS AND CURRENT DENSITIES (FROM SCHWAN, IN TAYLOR & CHEUNG, 1977).

<u>Effect</u>	<u>Current in Milliamperes</u>			
	<u>Men</u>	<u>Women</u>	<u>60 Hertz</u>	
			<u>Direct Current</u>	<u>RMS</u>
	<u>Men</u>	<u>Women</u>	<u>Men</u>	<u>Women</u>
No sensation on hand	1	0.6	0.4	0.3
Slight tingling. Perception threshold	5.2	3.5	1.1	0.7
Shock--not painful and muscular control not lost	9	6	1.8	1.2
Painful shock--painful but muscular control not lost	62	41	9	6
Painful shock--let-go threshold	76	51	16.0	10.5
Painful and severe shock muscular contractions, breathing difficult	90	60	23	15
Possible ventricular fibrillation from short shocks:				
a) Shock duration 0.03 second	1300	1300	1000	1000
b) Shock duration 3.0 seconds	500	500	100	100
c) Certain Ventricular fibrillation (if shock duration is over one heart beat interval)	1375	1375	275	275

TABLE 9. EFFECTS OF ELECTRIC CURRENTS AT POWER LINE FREQUENCIES (FROM FRAZIER, 1978).

Threshold for pain at 3 GHz

Power Density (W/cm <sup>2</sup> )	3.1	2.5	1.8	1.0	0.83
Exposure Time (sec.)	20	30	60	120	180

Power density and exposure time  
to produce sensation of warmth

Exposure Time (sec.)	Power Density at 3 GHz (mW/cm <sup>2</sup> )	Power Density at 10 GHz (mW/cm <sup>2</sup> )	Power Density at far infrared (mW/cm <sup>2</sup> )
1	58.6	21.0	4.2 - 8.4
2	46.0	16.7	4.2
4	33.5	12.6	4.2

TABLE 10. EFFECTS OF ELECTROMAGNETIC RADIATION AT SOME MICROWAVE AND HIGHER FREQUENCIES (FROM STUCHLY, 1978).

---

Headaches  
Eyestrain  
Fatigue  
Dizziness  
Disturbed sleep at night  
Sleepiness in daytime  
Moodiness  
Irritability  
Unsociability  
Hypochondriac reactions  
Feelings of fear  
Nervous tension  
Mental depression  
Memory impairment  
Pulling sensation in the  
scalp and brow  
Loss of hair  
Pain in muscles and heart  
region  
Breathing difficulties  
Increased perspiration of  
extremities  
Difficulty with sex life

---

TABLE 11. SUBJECTIVE EFFECTS ON PERSONS WORKING IN RADIO FREQUENCY ELECTROMAGNETIC FIELDS (FROM DWYER, 1978).

---

Symptomatology

Bradycardia  
Disruption of the endocrine-humoral process  
Hypotension  
Intensification of the activity of thyroid gland  
Exhausting influences on the central nervous system  
Decrease in sensitivity to smell  
Increase in histamine content of the blood

Subjective Complaints

Increased fatigability  
Periodic or constant headaches  
Extreme irritability  
Sleepiness during work

---

TABLE 12. CLINICAL MANIFESTATIONS OF CHRONIC OCCUPATIONAL EXPOSURE OF 525 WORKERS TO ELECTROMAGNETIC RADIATION AT MICROWAVE FREQUENCIES (FROM DWYER, 1978).

Test Subject (Investigator)	Electric Field (V/m)	Frequency (Hz)	Biological Parameter Examined	Results	Reviewed by
Substation workers in U.S.S.R. (Asanova and Rakov, 1966)	$8-14.5 \times 10^3$	50		(+) nervous system disorders	Shepard & Eisenbud, NAS
Humans in laboratory (Hauf, R., 1974)	$1-20 \times 10^3$	50	blood values, blood pressure pulse, ECG, EEG, reaction time	(+) leukocytes, neutrophils, reticulocytes increase but within normal range (-) other factors	Shepard & Eisenbud, EIS (Bridges & NAS review equivalent 1973 paper)
Human (Johansson, <u>et al.</u> , 1973)	$20 \times 10^3$	50	psychological tests	(-)	Bridges, Shepard & Eisenbud, EIS
Human (Johansson, <u>et al.</u> , 1972)	$20 \times 10^3$ at head	b	subjective feeling and psycho- logical functioning	(+) a few subjects showed re- duced ability and tension for pulse test (-) for sine wave test	
Human Linemen (Kouwenhoven, 1966)	Fields encountered in normal line and barehand work	60	physical examination CV, thyroid, kidney, urine, ECG, EEG, visual, auditory, X-ray, emotional stress	(-)	Bridges, NAS
Human, lice, yeast, bacteria, wheat germ (Konig, 1962)	1-2	c	human reaction time, growth of other test specimens	(+) reaction time increased or decreased depending on signal characteristics. Growth changes in other specimens	NAS
Humans--Comparison of "Opera- tions" to "Maintenance" per- sonnel U.S.S.R. (Sazanova, 1967)	open switchyard environment	50	temperature, pulse, blood pressure, reaction time, flicker frequency, adductor muscle reaction	(+) average blood pressure of maintenance personnel lower	NAS, EIS
Human, Lineman (Singewald, <u>et al.</u> , 1973)	Fields encountered in normal line and barehand work	60	same as Kouwenhoven, 1966; this is a follow-up report	(-)	Shepard & Eisenbud,
Humans--Comparison of those near and far from 200-400 kV lines (Strumza, 1970)	$< 7 \times 10^3$	50	visits to and from physicians, use of medicine, medical histories	(-) no statistically significant difference	Bridges, Sheppard & Eisenbud, EIS

NOTES: (a)  $147 \times 10^6$  modulated by ELF signal.

(b) Pulse simulating lightning, 3-14 Hz  
swept sine wave.

(c) 2-100. Natural and man-made simulations  
of geomagnetic signals.

TABLE 13. CLINICAL AND SUBJECTIVE EFFECTS OF ELECTROMAGNETIC FIELDS AT POWER LINE FRE-  
QUENCIES (FROM FRAZIER, 1978).



RESEARCHER	NUMBER OF SUBJECTS	FREQUENCY OR BAND	FIELD STRENGTH/ POWER DENSITY	EFFECTS
Pazderova	58	48.5-230 MHz	0-22 $\mu\text{W}/\text{cm}^2$	Increased plasma protein levels
Sadicikova	1180		30-3,000 $\mu\text{W}/\text{cm}^2$	Fatigue, irritability, sleepiness, memory loss, bradycardia, hypertension, hypotension, cardiac pain, systolic murmur, "microwave sickness"
Kalyada		40-200 MHz	"nonthermal"	Vegetative dysfunction of central nervous system; thermoregulatory pathology; cardiovascular changes; elevation of plasma cholesterol; gastritis; ulcers.
Klimova- Deutschova	530	1-150 MHz 300-800 MHz 3-30 GHz	0.1-3.3 $\text{mW}/\text{cm}^2$	Electroencephalographic disorders; elevation of fasting blood glucose; elevation of serum beta-lipoproteins; elevation of cholesterol.

TABLE 14. EFFECTS CITED IN PAVE PAWS REPORT.

RESEARCHER	NUMBER OF SUBJECTS	FREQUENCY OR BAND	FIELD STRENGTH/ POWER DENSITY	EFFECTS
Gabovich & Zhukovskiy	66	centimeter waves	to 370 $\mu\text{W}/\text{cm}^2$	Increase in threshold of red, green, and blue light.
Zalyubovskaya & Kiselev	102		to 1 $\text{mW}/\text{cm}^2$	Fatigue, drowsiness, headaches, loss of memory, decrease in hemoglobin, decrease in erythrocytes, hypercoagulation, decrease in leukocytes, increase in lymphocytes, decrease in segmentonuclear neutrophils, increase in reticulocytes, increase in thrombocytes, decrease in osmotic and acid resistance of erythrocytes, decrease in bactericidal action of skin and oral cavity, decrease in blood serum lysozyme, decrease in phagocytic activity of neutrophils.

TABLE 15. EFFECTS CITED BY MCCREE AND SHANDALA, 1980.

RESEARCHER	NUMBER OF SUBJECTS	FREQUENCY OR BAND	FIELD STRENGTH/ POWER DENSITY	EFFECTS
Sadchikova (USSR)		"microwaves"	0.03-3 mW/cm <sup>2</sup>	Reversible changes in nervous and cardiovascular systems and blood; "radio sickness".
Baranski & Edelwejn (Poland)		"microwaves"		Decrease in EEG alpha rhythm; decreased tolerance of neurotropic drugs.
Lancranjan (Romania)	31	"microwaves"	10-100 mW/cm <sup>2</sup>	Decrease in sex function; decrease in spermatogenesis.
Pazderova (Czechoslovakia)				Change in blood protein chemistry.
Slotolnik- Baranska				Chromosome changes in human leukocytes.

TABLE 16. EFFECTS CITED BY GLASER, IN JOHNSON & SHORE, VOL. 1, 1976.

EmF parameters		Ratio of percentage of cases with particular defect due to EmF to percentage of cases in control (not exposed to EmF)		
range	intensity	reduced blood pressure (arterial hypotonia)	slow heart beat (bradycardia)	QRS interval in ECG increased to 0.1 sec (reduced ventricular conductivity)
SHF (centimeter waves)	From one to several $\text{mW/cm}^2$	1.85	24	11.5
	$< 1 \text{ mW/cm}^2$	2.0	16	12.5
UHF	Low, not thermal	1.2	8	21
Short-wave HF	Tens to hundreds of $\text{V/m}$	0.21	12	—
Medium-wave HF	Hundreds to $1000 \text{ V/m}$	1.2	5	—
Percentage of cases in control		14%	3%	2%

TABLE 17. CARDIOVASCULAR DISTURBANCES IN PERSONS CHRONICALLY EXPOSED TO ELECTROMAGNETIC RADIATION AT VARIOUS FREQUENCIES (FROM PRESMAN, 1970).

RESEARCHER	NUMBER OF SUBJECTS	FREQUENCY OR BAND	FIELD STRENGTH/ POWER DENSITY	EFFECTS
Eckert (Germany)	494	60 Hz		Crib death (Sudden Infant Death Syndrome).
Bogucka (Poland)	72	"radio and television"		Functional disorders of central nervous system, hyperacidity, epigastric pain, disorders of cardiovascular system, leukopenia of blood, esinophobia of blood.
Bise (United States)	10	0.1-960 MHz	$10^{-16}$ - $10^{-13}$ W/cm <sup>2</sup>	Changes in electroencephalogram, loss of memory, inability to concentrate, irritability, apprehension.
Dumanskii (USSR)	34	50 Hz	5-12 kV/m	Local changes in skin temperature, reduced heart rate, reduced blood pressure, change in electrocardiogram, change in blood composition.
Katorgina, Semenova, et al	230	2-1000 kHz	3-5 V/m	Eye pain, headache, vascular changes in eye.
Alberti (Italy)	31	5-50 MHz		Decreased male fertility, insomnia, headache.
Holt (Australia)		VHF	Below 10 mW/cm <sup>2</sup>	Cancer growth stimulated.
Lovsund, Obey, Nilsson (Sweden)		10-50 Hz	0-40 milli-Teslas	Excitation of magnetophosphenes.

TABLE 18. EFFECTS CITED BY KLEINSTEIN &amp; DYNER, 1980.

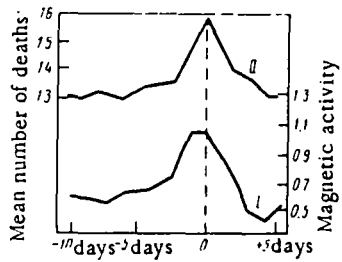

Magnetic storms (I) and mortality from nervous and cardiovascular diseases (II) in Copenhagen and Frankfurt-on-Main.

FIG. 10. RELATION BETWEEN NATURALLY OCCURRING MAGNETIC FIELDS AND DEATH RATE (FROM BERG, 1960, IN PRESMAN, 1970).

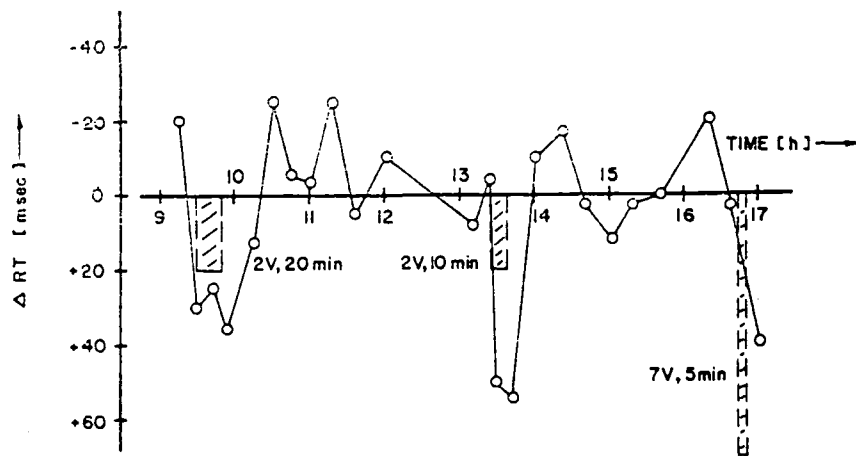

FIG. 11. EFFECT OF A 3-HERTZ, VERTICALLY POLARIZED, ELECTRIC FIELD ON THE REACTION TIME OF A SINGLE TEST SUBJECT IN A SINGLE-BLIND EXPERIMENT (FROM KONIG, IN PERSINGER, 1974). THE DURATION AND INTENSITY OF EXPOSURE ARE INDICATED BY THE SHADED AREAS. THE VOLTAGES WERE APPLIED BETWEEN PLATES 2.5 METERS APART. THE TIME-DEPENDENCE OF THE FIELD WAS INTENDED TO RESEMBLE THE TYPE II SIGNAL SHOWN PREVIOUSLY IN FIG. 2.

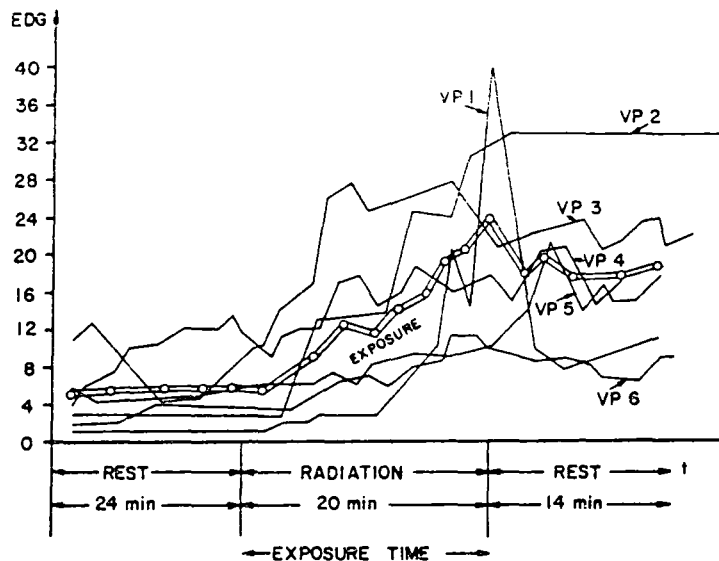
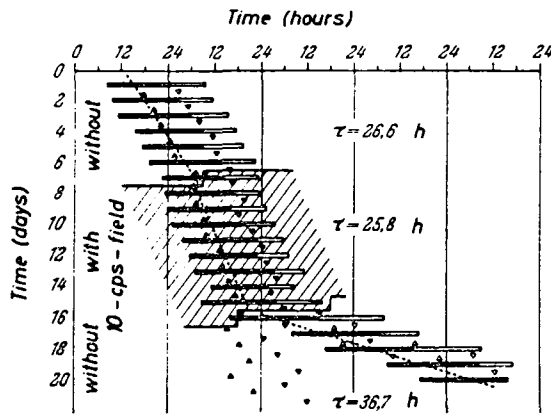
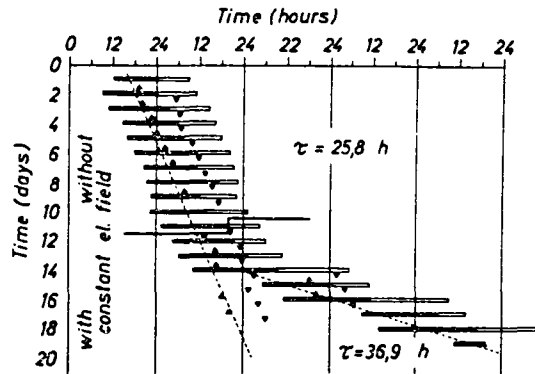

FIG. 12. EFFECT OF A 3-HERTZ ELECTRIC FIELD ON GALVANIC SKIN RESPONSE (FROM KONIG, IN PERSINGER, 1974). THE TIME-DEPENDENCE OF THE FIELD WAS INTENDED TO RESEMBLE THE TYPE II SIGNAL SHOWN PREVIOUSLY IN FIG. 2. FOR AN APPLIED FIELD INTENSITY OF 1 V/M, POSITIVE REACTION WAS OBSERVED IN 1 OF 12 TEST SUBJECTS. FOR 5 V/M, POSITIVE REACTION WAS OBSERVED IN 5 OUT OF 10 TEST SUBJECTS.





Free-running circadian rhythm of a subject living under strict isolation from environmental time cues, during the first and third sections protected from natural and artificial electromagnetic fields, during the second section under the influence of a continuously operating electric 10-cps field.



Free-running circadian rhythm of a subject living under strict isolation from environmental time cues, during the first section protected from natural and artificial electromagnetic fields, during the second section under the influence of a continuously operating artificial electric DC-field.

FIG. 13. EFFECTS OF 2.5 VOLT/METER, 10-HERTZ AND 300 VOLTS/METER, STATIC ELECTRIC FIELDS ON CIRCADIAN RHYTHM (FROM WEVER, IN PERSINGER, 1974).

Residence	Type of wiring configuration*	Leukemia		Lymphoma		Nervous system tumors		Other	
		Case	Control	Case	Control	Case	Control	Case	Control
Birth address	HCC	52	29	10	5	22	12	17	9
	LCC	84	107	21	26	35	45	31	39
	(% HCC)	(38.2)	(21.3)	(32.3)	(16.1)	(38.6)	(21.1)	(35.4)	(18.7)
Death address	HCC	63	29	18	11	30	17	18	17
	LCC	92	126	26	33	36	49	45	46
	(% HCC)	(40.6)	(18.7)	(40.9)	(25.0)	(45.5)	(25.8)	(28.6)	(27.0)

\* HCC = high-current configuration; LCC = low-current configuration.

TABLE 19. RELATION BETWEEN CHILDHOOD CANCER AND PROXIMITY OF RESIDENCE TO CERTAIN 60-HZ TRANSMISSION LINES (FROM WERTHEIMER & LEEPER, 1979).

Symptoms	Length of Employment			
	1-6 years (average 4.3) (73 persons)		7-16 years (average 9.6) (73 persons)	
	percent of cases	number of cases	percent of cases	number of cases
Headache	20.5	15	32.9	24
Disturbance of sleep	13.7	10	23.3	17
Fatigue	12.3	9	17.8	13
General weakness	7.0	5	12.3	9
Disturbance of memory	5.5	4	8.2	6
Lowering of sexual potency	5.5	4	8.2	6
Drop in body weight	2.7	2	12.3	9
Disturbance of equilibration	5.5	4	11.0	8
Neurological symptoms	0.0	0	15.1	11
Changes in ECG	17.8	13	28.8	21

TABLE 20. OCCURRENCE OF SOME SYMPTOMS IN HUMANS EXPOSED OCCUPATIONAL-  
LY TO ELECTROMAGNETIC RADIATION IN THE FREQUENCY RANGE  
750 KHZ-200 MHZ (FROM DWYER, 1978).

THRESHOLD FOR MICROWAVE-INDUCED AUDITORY EFFECT IN HUMAN  
SUBJECTS (45 dB BACKGROUND NOISE, 2450 MHz)

Pulsewidth ( $\mu$ s)	Peak power (W/cm <sup>2</sup> )	Peak SAR* (W/g)	Average power ( $\mu$ W/cm <sup>2</sup> )
1	40	16	120
2	20	8	120
4	10	4	120
5	8	3.2	120
5	2.5	1.0	25
10	4	1.6	120
10	1.3	0.5	26
15	2.33	0.93	105
15	5	2.0	150
20	2.15	0.86	129
32	1.25	0.5	120

\*Peak SAR (specific absorption rate) is based on absorption in equivalent spherical model of the head

TABLE 21. SOME CHARACTERISTICS ASSOCIATED WITH MICROWAVE HEARING (FROM LIN, 1980).

Exposure level	Frequency of complaint, percentage		
	Neurological	Brachycardia	Abnormal cardiac ST waves
High (over 200 mW/cm <sup>2</sup> )	32	1.63	11.8
Low (10-200 mW/cm <sup>2</sup> )	24	3.93	11.2
None (control group)	11	0.42	5.6

TABLE 22. SURVEY OF 1300 CHINESE "MICROWAVE WORKERS" (FROM LERNER, 1980).

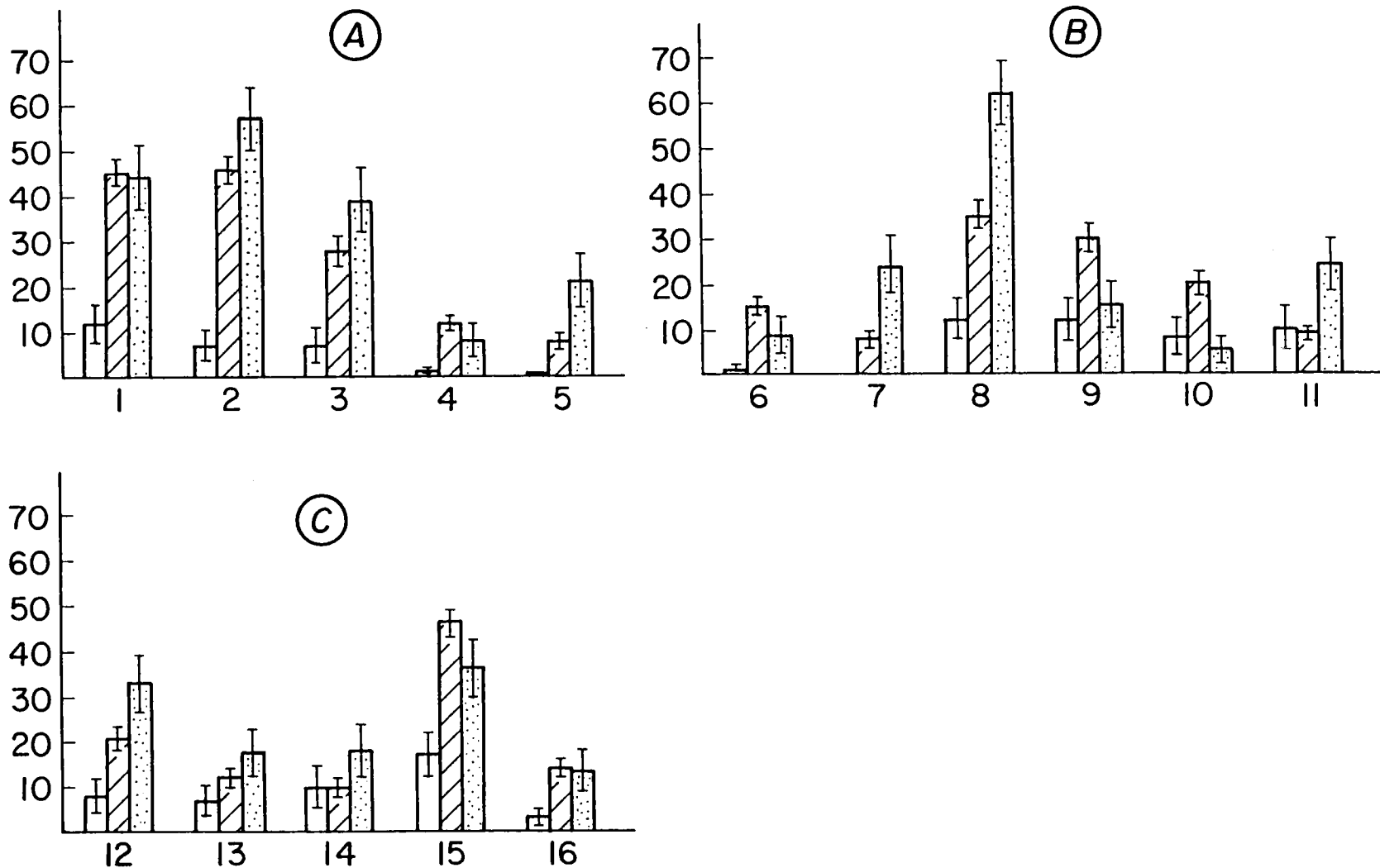

Ordinate - frequency of changes in percentages; abscissa - main indicators: A - neurological, B - autonomic vascular and C - cardiac. White columns - control; oblique shading - persons of the first group, exposed previously to periodic action of microwaves of substantial intensities; dotted shading - persons of the second group working under conditions of exposure to microwaves of lower intensities. All indicators are presented with confidence limits. 1 - feeling of heaviness in the head, 2 - tiredness, 3 - irritability, 4 - sleepiness, 5 - partial loss of memory, 6 - inhibited dermographism, 7 - expressed dermographism, 8 - hyperhidrosis, 9 - bradycardia (upon counting), 10 - arterial hypotension, 11 - arterial hypertension, 12 - cardiac pain, 13 - dullness of the heart sounds, 14 - systolic murmur, 15 - bradycardia (according to ECG), 16 - lowering of deflections T I and T II.

FIG. 14. CHANGES IN THE NERVOUS AND CARDIOVASCULAR SYSTEMS AMONG WORKERS EXPOSED TO MICROWAVES AND CONTROL SUBJECTS (FROM STUCHLY, 1978).



Percentages of headaches vs years of work. ■, Exploitation; □, special exploitation; ▨, repair.

FIG. 15. OCCURRENCE OF HEADACHES IN "MICROWAVE WORKERS" (FROM BARANSKI & EDELWEJN, IN TYLER, 1975).



Percentages of oversweating vs years of work.

FIG. 16. OCCURRENCE OF EXCESSIVE PERSPIRATION IN "MICROWAVE WORKERS" (FROM BARANSKI & EDELWEJN, IN TYLER, 1975).



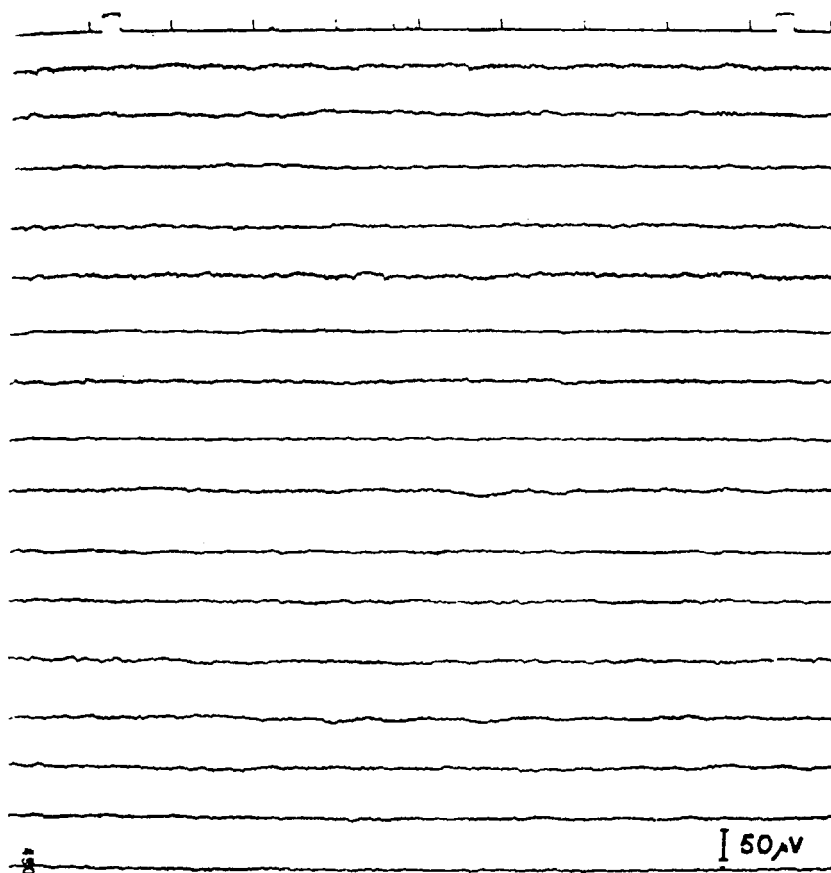

EEG tracings in an individual occupationally exposed for 5 years to microwaves (group R) while working in a repair shop.

FIG. 17. SUBSTANTIALLY FLAT ELECTROENCEPHALOGRAMS OF "MICROWAVE WORKERS" (FROM BARANSKI & EDELWEJN, IN TYLER, 1975).

## Beneficial Effects

Electromagnetic field effects have both established and developing uses in medicine. In addition, some alleged benefits have not been acknowledged in medical circles.

Table 23 is a summary of various beneficial effects, at frequencies ranging from 0-434 MHz. Most of these are included in the broad category of electromagnetic diathermy. That is, electromagnetic fields are used to heat various parts of the body. It is generally believed that heat stimulates the natural healing and/or defense mechanisms to relieve or cure the ailment. Of all known effects, relief by diathermy is probably the oldest, beginning in 1892 when D'Arsonval observed tissue heating due to low frequency electric currents. Comprehensive text books on the technique appeared by the early part of this century (*e.g.* Danzer *et al*, 1938).

The table also includes two techniques, however, which have been used only recently compared to diathermy. They are: bone healing and hyperthermia. The table shows that Brighton and Friedenberg have used microampere currents to mend stubborn bone fractures. Not shown is similar work by Bassett, who reportedly used 75 Hz pulsed currents of only a few nanoamperes to produce bone healing. Note that in either case, the currents are so small that heating probably is not part of this effect. With respect to hyperthermia, the table shows that Holt and Nelson reported positive results in the treatment of a great variety of cancers. Briefly, the objective of hyperthermia is to raise the temperature of cancerous tissue to 42-45 degrees Centigrade. In that range, the cancer cells tend to die, but healthy cells manage to survive as they would during a high fever. The reason for the preferential survival is generally attributed to the relatively poor circulatory system of cancerous tissue. That is, lack of blood prevents the cancer cells from dissipating lethal amounts of heat energy.

Electromagnetic hyperthermia is increasingly used as part of cancer treatment, as indicated by Tables 24 through 26 and Figures 18 and 19. Table 24 shows that three different frequencies (27, 915, and 2450 MHz) are used. The chief reason is that the electro-

magnetic spectrum is regulated, and only certain frequencies have been reserved for such use. These constitute the ISM (Industrial, Scientific, and Medical) band and include the frequencies 13, 27, 40, 915, 2450, and 6000 MHz. Note that Holt and Nelson (Table 23) used 434 MHz in Australia, but that frequency is not available in the United States. Of the ISM band, 915 MHz is closest to a physical optimum, in the sense that absorbed power is maximum for much bulk tissue.

Table 25 shows how hyperthermia is used in conjunction with more traditional forms of cancer therapy, such as chemotherapy and ionizing radiation. The latter seem to be so much more effective when used simultaneously with hyperthermia that only very small doses (about 10% of the usual amount) are required. Therefore, the toxic side effects are largely avoided and prolonged treatment is feasible.

Table 26 shows how hyperthermia is realized at a variety of local sites on or in the body, and some of the associated problems. Electromagnetic fields are applied using specialized antennas. In medicine, these have been given a special name, "applicators". Typically, they couple 1-100 watts into various parts of the body.

Figs. 18 and 19 show two different applicators. The bean bag type is suitable for the surface of the body. The coaxial type is designed for use inside the body.

The tables and figures do not include a number of both traditional and experimental electromagnetic field effects. The former include: defibrillation; various types of shock treatment; and diagnosis using the body's own electromagnetic signals, such as the electrocardio- and electroencephalogram. The novel ones include at least two diagnostic techniques, microwave thermography and microwave scanning.

Microwave thermography is a passive technique similar to radiometry. The electromagnetic signature of cancerous breast tissue seems to be unique. The advantage over conventional X-rays is the apparent lack of toxic effects. Two different frequencies are presently being used, 3.3 and 1.3 GHz (Barret and Myers, 1979).

Microwave scanning is a bistatic radar system. That is, the transmitting and receiving antennas are at different (in this case, opposite) sites. Evidently, microwaves passing through an organ can be used to construct a high resolution image of it, rivaling

those obtained using conventional X-rays. This is possible in part due to the high bulk dielectric constant of tissue, so that, at a fixed frequency, a wave length in the organ is about one-ninth what it would be in air. For example, at 3 GHz a wave length is only 1.1 centimeter. For purposes of radar imaging, the smaller the wave length, the greater the resolution. The advantage over X-rays is apparent lack of toxic effects.

Finally, one controversial beneficial effect concerns negative airborne ions. Reportedly, these can impart a feeling of exuberance and general well being. Positive ions reportedly have the opposite effect. This belief supports a world wide ion generator industry.

RESEARCHER	NUMBER OF SUBJECTS	FREQUENCY OR BAND	FIELD STRENGTH/ POWER DENSITY	EFFECTS
Mannheimer (Sweden)	20	3-70 Hz		Relief of arthritis pain.
Dikova (Bulgaria)	87	"radar"	30 watts	Cured sterility in women.
Bentall (UK)	50	500 Hz		Accelerated bruise healing.
Nikoruikina (USSR)	152	"microwave"	40 watts	Relief of chronic colitis and pancreatic disorders.
Brighton & Friedenberg (United States)	57	0 Hz	10-20 microamps	Healed bone fractures.
Debelle, Lorthiour, et al (Belgium)		27.12 MHz	1.5 watts	Cured arterial ulcer; relief from varicose veins, eczema, arthritis; healed bone fractures.
Novak (Czechoslovakia)	141	0 Hz	40-480 gammas	Relief/cures relating to bronchial asthma, neuralgia, epilepsy, stenocardia, photodermatoses.
Holt & Nelson (Australia)	1300	434 MHz		Improvement in patients with cancers of the: head, neck, breast, bone, liver, brain, lung, abdomen, rectum, bladder, sarcomata, lymphomata.

TABLE 23. BENEFICIAL EFFECTS CITED BY KLEINSTEIN &amp; DYNER, 1980.

Tumor Location	Pathology	Treatment Method
Breast	Adenocarcinoma—local recurrence	2450-MHz cross-fire conformal applicators
Breast	Adenocarcinoma—local recurrence	2450-MHz ceramic waveguide applicator
Skin	Metastasis from cancer of breast, post-mastectomy	915- and 2450-MHz air-filled waveguide applicators
Lung	Carcinoma	27-MHz water-filled ridged waveguide applicator
Leg	Liposarcoma—recurrence—post surgery	27-MHz water-filled ridged waveguide applicator
Leg	Disseminated metastatic melanoma	2450-MHz ceramic waveguide applicator
Leg	Squamous carcinoma	2450-MHz conformal applicator
Foot	Primary melanoma	2450-MHz ceramic waveguide and conformal applicators
Eye	Primary melanoma	2450-MHz ceramic waveguide applicator
Head and neck	Primary melanoma, carcinoma of tonsils, sarcoma of tongue, squamous carcinoma	915- and 2450-MHz ceramic waveguide applicators
Prostate	Carcinoma	915- and 2450-MHz coaxial applicators and 27-MHz water-filled ridged waveguide applicator
Cheek	Carcinoma	2450-MHz cross-fire conformal and coaxial applicators
Axilla	Metastatic skin lesion from breast carcinoma	2450-MHz conformal applicator
Abdomen	Skin metastasis from sarcoma of colon	2450-MHz conformal applicator
Abdomen	Pelvic metastasis from colorectal adeno- carcinoma	27-MHz water-filled ridged wave applicator
Scalp	Metastasis from lung carcinoma	2450-MHz ceramic waveguide and conformal applicators
Vagina	Melanoma	2450-MHz ceramic waveguide applicator

TABLE 24. PROFILES OF CASES AND MODALITIES OF HYPERTHERMIA (FROM STERZER ET AL, 1980).

Anatomic Extent	Method	Temperature	Time	Adjuvant Therapy	Comments and Considerations	References
Whole Body	Hot air and/or radiant heat	41-41.5	5-21 h	X-ray	Cumbersome—limited access to patient	Warren
	Hot water by immersion	40	2½ h	*	Slow temperature control	Von Ardenne
	Hot water by <i>space suit</i>	39.5-42	90 min-5 h	Systemic chemotherapy	*	Larkin, Bull
	Melted paraffin by immersion	41-41.8	90 min-4 h	Cytotoxic drugs	Limited access to patient	Pettigrew
	Perfusion—extracorporeal heat exchange	41.5-42	5 h	Cytotoxic drugs	Surgical procedure	Parks
	Microwave and hot air cabinet (Siemens)	43-43.6	40 min-1 h	*	*	Moricca
Regional	Hot water by immersion	46-47	67 min	X-ray, cytotoxic drugs	Limited to extremities	Crile
	Radiant heat—visible and infrared	43-45	20 min	*	*	Lehmann
	Perfusion	38-45	30 min-8 h	X-ray, chemotherapy, cytotoxic drugs	Surgical procedure	Cavaliere, Stehlin, Shingleton, Woodhall
	Capacitive RF	42-50	30 min-3 h	*	Skin and fat burns have been a problem.	LeVeen, Storm
	Inductive RF	41-63	35 min	*	*	Storm
Localized	Irrigation	41-45	1-3 h	*	Bladder tumors, peritoneal cavity	Hall <i>et al.</i> Ludgate
	Capacitive RF	48.4	30 min-3 h	*	*	LeVeen, G. Hahn
	Inductive RF	42.8-45	30 min-1 h	X-ray	*	Kim and Hahn, Von Ardenne
	Ultrasound	43.5	30 min	*	Best focusing. Reflections, cavitation, and bone heating are problems.	G. Hahn
	Microwave	42-44	12-20 min	*	Deep heating (10 cm) difficult with noninvasive (NI) applicators.	Sandhu, Dickson, Mendecki, Samaris, <i>et al.</i>

TABLE 25. REPORTED HYPERTHERMIA MODALITIES (FROM SHORT &amp; TURNER, 1980).

Site	Estimated New Cases	Estimated Deaths	Possible Regional or Local Hyperthermic Approaches				Problems and Considerations
			ULT	CAP	IND	MIC	
Buccal cavity and pharynx	24 400	8650	NI	NI	NI	NI	Proximity to eyes, complex geometry—reflections, uneven heat deposition. Specialized applicators. High vascular perfusion.
Esophagus	8400	7500	—	OR	NI	OR	Local metastases at first diagnosis. Large blood vessels adjacent. Difficult thermometry (danger of mediastinitis).
Stomach	23 000	14 100	—	NI OR	NI	OR	Local metastases at first diagnosis. Difficult geometry and placement of applicators. Some success with WBH and hyperthermic irrigation.
Colon	77 000	42 800	—	NI	NI	NI OR OP	Right colon not accessible by orificial applicator (too deep). Adjacent loops of bowel containing liquids and gases. Thermometry difficult.
Rectum	35 000	9100	—	OR	NI	OR IN	Metastases in regional lymph nodes may be difficult to heat.
Liver and biliary	11 600	9200	NI	NI	NI	NI	Most sensitive tissue to heat. Large organ. Usually good differential heating of tumors. Gall bladder contents may overheat.
Pancreas	23 000	20 200	NI	NI	NI	NI OR OP	Deep, inaccessible. Intestinal mucosa are heat sensitive. Thermometry difficult. May require surgical implantation—active and passive radiators and temperature probes.
Larynx	10 400	3500	NI	—	—	NI OR	Good candidate for hyperthermia—accessible, early symptoms, second chance laryngectomy if hyperthermia fails.
Lung	112 000	97 500	—	NI	NI	NI OP	Often far advanced at first diagnosis, metastasis common. Geometry difficult—air, bone, major vessels. Thermometry tricky.
Bone and connective tissue	6400	3350	NI	—	NI	NI	Commonly metastasize to lung. Problems relate to size and location, etc.
Breast	106 900	34 500	NI	NI	NI	NI IN	Deep surface against muscle may be harder to heat. Metastases to axillary lymph nodes often small (1 mm). Synchronous phased array?
Melanoma	13 600	4300	NI	—	—	NI	Metastasize widely.
Uterus	53 000	10 700		OR IN	NI	OR IN OP	Nonsurgical candidates have local extension which is deep for external applicators, distant from intrauterine cavity.
Ovary	17 000	11 100	—	—	NI	NI OP	Many tumors cystic, large, easily ruptured—thermometry difficult. Tumors deep in pelvis. Disseminate through peritoneal cavity.
Prostate	64 000	21 000	NI	OR	—	NI OR	Metastasize to lower spine.
Brain	11 600	9500	IN		NI	IN OP	Reflections, resonance, fluid-filled ventricles, proximity to eyes. Surgical procedure for invasive applicators and temperature probes. Hyperthermic chemotherapeutic perfusion?
Thyroid	9000	1000	NI	—	NI	NI	Adjacent tissue has many large blood vessels and important nerves.
Leukemia	21 500	15 400	—	—	—	—	Diffuse disease. Whole body hyperthermia with chemotherapy and/or X-irradiation? Extracorporeal hyperthermia of blood?
Lymphoma	38 500	20 300	NI	NI	NI	NI	Often diffuse. May be difficult to heat preferentially. Dosimetry may be difficult.
Bladder	35 000	10 000			NI	OR	Temperature probe placement tricky in invasive tumors. Some success with hyperthermic irrigation.
Kidney	16 200	7500	NI	NI	NI	NI IN	May require X-ray placement of temperature probes and IN applicators.
All sites	765 000	395 000					

Abbreviations: ULT—Ultrasound, CAP—Capacitive RF, IND—Inductive RF, MIC—Radiative UHF, microwave, NI—Noninvasive, IN—Invasive, OR—Natural orifice (orificial), OP—Operative (surgical exposure), WBH—Whole body hyperthermia.

TABLE 26. SELECTED CANCER STATISTICS AND HYPERTHERMIA CONSIDERATIONS (FROM SHORT & TURNER, 1980).



Bean-bag applicator designed for operation at 2450 MHz uses multiple printed-circuit dipole antennas. The base conforms to the contours of the body. The mesh around the applicator minimizes the extraneous radiation. This type of applicator is used for treating one or more shallow tumors in a large area.

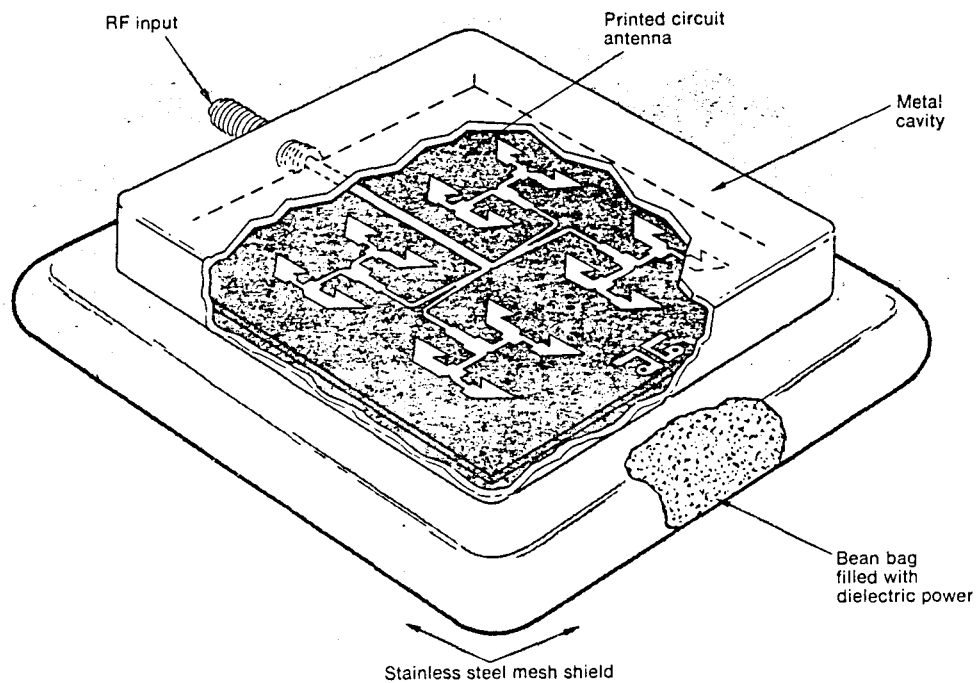
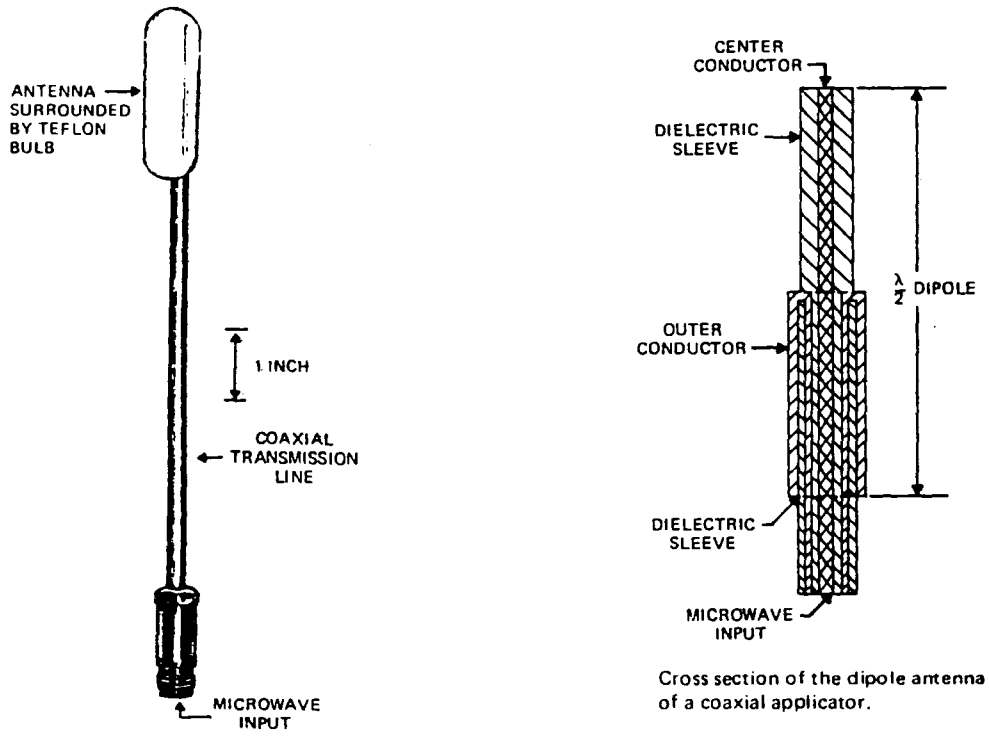

FIG. 18. BEAN BAG TYPE APPLICATOR FOR HYPERTHERMIA (FROM STERZER ET AL, 1980).



Coaxial applicator designed for operation at 2450 MHz.

FIG. 19. COAXIAL TYPE APPLICATOR FOR HYPERTHERMIA (FROM STERZER ET AL, 1980).

## Physical and Physiological Foundations

A great variety of theories have been developed to help understand the effects described in the preceding sections. In this section, the theories are presented roughly in order of how homogeneous the human body is assumed to be. At one extreme, it may be regarded as a simple shape (*e.g.* a prolate spheroid) with a single set of electromagnetic constants (permittivity, permeability, and conductivity). In that sense, the body is a simple antenna or probe capable of intercepting a certain amount of electromagnetic energy, which is converted entirely into heat. At the other extreme, the body may be regarded as a collection of countless electronic microcircuits, each one corresponding to an individual cell or part thereof. Electromagnetic energy somehow finds its way to individual microcircuits and influences the electronic functions there. These functions include various communication and control processes essential to life and its activities. Probably neither extreme is a totally correct or incorrect viewpoint, and each provides useful physical insights.

### *Theories Based on Power Dissipation*

Figs. 20 and 21 follow from adopting the simplest point of view (*i.e.* modeling the human body as a homogeneous, prolate spheroid). Fig. 20 shows qualitatively the electric current densities that result from electric and magnetic fields. These can be calculated exactly by solving Maxwell's Equations for a prolate spheroid, a task that is straight forward but tedious. Because the body is resistive, the currents result in the dissipation of power. If the longitudinal axis of the body is parallel to the electric field, then the total dissipated power is given by the formula,

$$P_E = 43.42 S \sigma k^2 \left[ \left( \frac{B_e}{\sigma \eta} \right)^2 + \frac{(ab)^2}{5(a^2+b^2)} \right] \frac{4\pi ab^2}{3} \quad (5)$$

If it is parallel to the magnetic field, the appropriate formula is:

$$P_H = 43.42 S \sigma k^2 \left[ \left( \frac{B_h}{\sigma \eta} \right)^2 + \frac{b^2}{10} \right] \frac{4\pi a b^2}{3} \quad (6)$$

Finally, if it is parallel to the wave vector (which, for plane waves, is mutually orthogonal to both the electric and magnetic fields), the appropriate formula is:

$$P_K = 43.42 S \sigma k^2 \left[ \left( \frac{B_h}{\sigma \eta} \right)^2 + \frac{(ab)^2}{5(a^2+b^2)} \right] \frac{4\pi a b^2}{3} \quad (7)$$

In eqs. 5 through 7:  $S$  = incident power density in  $\text{mW}/\text{cm}^2$   
 $\sigma$  = conductivity of body  
 $k$  = wave number =  $2\pi/(\text{wave length})$   
 $\eta$  = impedance of free space =  $376.73035$  ohms  
 $a, b$  = major and minor semi-axes of prolate spheroid.

The coefficients  $B_e$  and  $B_h$  are:

$$B_e = \frac{1}{(u_{10}^2 - 1) \left[ \frac{u_{10}}{2} \ln \left( \frac{u_{10} + 1}{u_{10} - 1} \right) - 1 \right]} \quad (8)$$

$$B_h = \frac{1}{2(u_{10}^2 - 1) \left[ \frac{u_{10}^2}{u_{10}^2 - 1} - \frac{u_{10}}{2} \ln \left( \frac{u_{10} + 1}{u_{10} - 1} \right) \right]} \quad (9)$$

where:

$$u_{10} = \frac{a}{\sqrt{a^2 - b^2}} \quad (10)$$

Note that eqs. 5 through 7 show how results depend on the polarization of the electromagnetic field.

Fig. 21 shows how the dissipated power varies as a function of frequency for each of the three possible polarizations. Actually, the dependent variable in the figure is not exactly power but a quantity called the average "specific absorption ratio" or average "SAR". This is simply the dissipated power normalized by the mass of the body. The mathematical definition is:

$$SAR = \frac{P_d}{\rho} \quad (11)$$

where:  $P_d$  = dissipated power density  
 $\rho$  = mass density

Note that in eq. 11,  $P_d$  is not that total dissipated power. Rather, it is the dissipated power density, which, in general, is not constant throughout the volume of the body. Therefore, the SAR also varies.

Which of the above three quantities (current density, dissipated power, or SAR) is most physiologically meaningful is not clear. SAR seems to have received the most attention, however. It can be compared directly to the body's basal metabolic rate (BMR), at least because they have the same dimensions (watts per kilogram). This is done in Table 27. The BMR is a measure of how fast the body can convert incident energy into forms other than heat. So, if the SAR exceeds the BMR, then body temperature should rise. Temperature change is associated with some of the adverse and beneficial changes described in the previous sections, including cataracts, diathermy, and hyperthermia. So, the SAR concept is useful for understanding at least these effects.

The calculations of SAR and electric currents have been extended to geometries which are more complicated than prolate spheroids and which more closely resemble the human form. Fig. 22 shows such a geometry, composed of multiple cubes. Figs. 23 through 25 show some results obtained using the multiple cube model. As already noted, the SAR is not uniform throughout the body. Instead, there are "hot spots", or regions of the body where the SAR is distinctly greatest. The location and intensity of the hot spots change as functions of frequency and other parameters.

Fig. 26 demonstrates that current densities can also be calculated for detailed regions of the body.

The sort of computations described thus far require an *a priori* knowledge of electromagnetic constants (permittivity, permeability, and conductivity) for various parts of the body. These have been measured extensively, at least for bulk tissue, which is adequate for the multiple cube and simpler geometries. Tables 28 and 29 and Figs. 27 and 28 show values for many of the constants. They are used to calculate the dissipated power density, and thus the SAR, according to the formula,

$$P_d = \frac{1}{2} (\omega \epsilon'' + \sigma) |\vec{E}|^2 \quad (12)$$

In eq. 12,  $\epsilon''$  is the imaginary part of the complex permittivity  $\epsilon$ , and  $\vec{E}$  is the electric field at the point of interest inside the body.

Fig. 28 emphasizes that the electromagnetic constants are actually frequency dependent composites. That is, tissue is not homogeneous but composed of different substances (*e.g.* membranes, fluids, and various particles). In general, each substance has different electromagnetic constants. The relative contributions from each substance to the composite electromagnetic constants may change with frequency. So, the theory and techniques described thus far are approximations which tend to ignore the detailed structure of tissue. This approximation may be acceptable, especially for modeling effects in which detectable tissue heating occurs. These are often termed "thermal" effects.

#### *Theories Based on the Movement of Charge*

On the other hand, many of the effects described in the previous sections do not seem to be associated with tissue heating or temperature changes. Examples include fibrillation, bone healing, and the various effects collectively known as neurasthenia, which seem to involve the central nervous system. These are often termed "athermal" effects. Efforts to understand these have focussed attention on the (microscopic) components of tissue (*e.g.* cells, membranes, fluids, molecules in solution) rather than the tissue taken as a whole.

According to one theory, an electric field can cause the agglomeration of particles (e.g. molecules in solution) which are normally separated. Figs. 29 and 30 show this process, which is called "pearl chain formation". The individual particles, or pearls, are electrically neutral but the electric field polarizes them. Then, they are attracted to each other, negative end to positive end. The minimum, or threshold, field strength required to sustain the process is given approximately by the formula,

$$E_{th} = 1.7 a^{\frac{2}{3}} \left| 2 + \frac{\epsilon_1}{\epsilon_2} \right| \sqrt{\frac{kT}{(\epsilon_1 - \epsilon_2) \operatorname{Re} \left( \frac{\epsilon_1 - \epsilon_2}{\epsilon_2} \right)}} \quad (13)$$

where:  $a$  = radius of particle

$\epsilon_1$  = permittivity of particle

$\epsilon_2$  = permittivity of ambient medium

$k$  = Boltzmann constant =  $1.381 \times 10^{-23}$  joules/deg.

$T$  = temperature

Due to the viscosity of the solution, the field must be applied for at least a time given by the formula,

$$\tau = \frac{12\pi\eta a^3}{\chi_{mn}^2 kT} \quad (14)$$

where  $\eta$  is viscosity and the  $\chi_{mn}$  are roots of the equation,

$$j'_n(\chi) y'_n\left(\frac{R}{a}\chi\right) - j'_n\left(\frac{R}{a}\chi\right) y'_n(\chi) = 0 \quad (15)$$

In eq. 15,  $j_n$  = spherical Bessel function of the first kind

$y_n$  = spherical Bessel function of the second kind

$2R$  = separation between particles in the absence of an applied field

The prime denotes a derivative.

The concept of pearl chain formation implies rather drastic changes can be induced within the body. Extensive numerical evaluation of the formulas and comparison with physiological data does not seem to be available in the literature, however.

In addition to particles in solution, theories have been developed concerning individual cells. Fig. 31 shows the equivalent electric circuit of a cell. Given an incident current density, and using the circuit model, the total current or current density actually passing across the cell membrane and through the cell can be calculated. If the current is sufficiently great, different responses are possible. For example, a current density of  $1 \text{ mA/cm}^2$  is about the amount associated with the action potential of nerve and muscle cells. Perhaps a pulsed electromagnetic field could simulate these action potentials and confuse the body by generating false signals.

Another response that has received much attention relates to the "blood brain barrier". The exact nature of this barrier is not resolved; however, according to at least one theory, it is composed of specialized cells which line the capillaries of the brain and central nervous system. Similar cells are not found elsewhere in the body. They are very tightly packed, so that substances cannot leak between them, and they carefully select those which may pass through them. Thus, they isolate the brain and central nervous system in a manner unique in the body. Evidently, electric currents cause the specialized cells to contract, allowing normally excluded substances to leak between them. The intensity, frequency, and other characteristics of the required current are not known at this time.

Of the cell's parts, the membrane probably has attracted most attention, at least with respect to electromagnetic effects. Many membrane properties can be stated quantitatively. Some of them are:

- Typical thickness: 45 angstroms
- Typical capacitance:  $1 \text{ microfarad/cm}^2$
- Typical leakage conductance:  $1\text{-}10 \text{ mhos/cm}^2$
- Typical resting potential: 100 millivolts



From the above numbers the following additional ones can be derived:

- Dielectric constant: 5
- Electric field:  $2.2 \times 10^7$  volts/meter
- Surface charge density:  $9.7 \times 10^{-8}$  coulombs/cm<sup>2</sup> =  
 $6.1 \times 10^{11}$  fundamental charges/cm<sup>2</sup>

Of these, perhaps the electric field is most remarkable because it is greater than almost any other found in nature. For example, recall from a previous section that the electric field at the earth's surface is only about 100 V/m.

Fig. 32 shows a typical voltage waveform which occurs across membranes in response to the body's natural excitation.

Equations and equivalent electronic circuits have been developed based on the membrane properties and waveforms just described. The voltage across the membrane is given by the Hodgkin-Katz ion (HKI) equation:

$$V = \frac{RT}{F} \ln \left( \frac{P_K [K_i^+] + P_{Na} [Na_i^+] + P_{Cl} [Cl_e^-]}{P_K [K_e^+] + P_{Na} [Na_e^+] + P_{Cl} [Cl_i^-]} \right) \quad (16)$$

In eq. 16,  $R$  = gas constant = 8.3143 joules/(degree-mole)

$T$  = temperature

$F$  = Faraday constant =  $0.96487 \times 10^5$  coulomb

The  $P$  are permeability constants, and the brackets denote concentrations of the ions within them. Subscripts  $i$  and  $e$  denote locations internal and external to the cell, respectively. An alternative to the HKI equation is the Association-Induction (AI) equation:

$$V = V_o - \frac{RT}{F} \ln \left( \tilde{K}_K [K_e^+] + \tilde{K}_{Na} [Na_e^+] \right) \quad (17)$$

where the  $\tilde{K}$  are adsorption constants.

The current across the membrane is given by the Hodgkin-Huxley equation, which has the form,

$$I = C \frac{dV}{dt} + g_K (V - V_K) + g_{Na} (V - V_{Na}) + g_L (V - V_L) \quad (18)$$

In eq. 18,  $C$  is the membrane capacitance and the  $g$  are leakage conductances. The latter are different for each charge species, and they are also nonlinear.

Fig. 33 shows a circuit model of the membrane based on eq. 18. As already noted, the conductances are nonlinear, and Fig. 34 shows how they change in time for a step excitation.

There is some similarity between the cell membrane and the p-n junction found in electronic semiconducting devices, such as diodes and transistors. Figs. 35 and 36 indicate this similarity. Both the membrane and p-n junction sustain a voltage between regions with different charge concentrations. At least one theory exploits this similarity. According to that theory, the membrane is a rectifying junction. The implications could be dramatic. Direct currents might be created from high-frequency ones, and different frequencies might be mixed to create new ones to which the body is more sensitive (*i.e.* resonant).

So far, the cell membrane has been treated as a homogeneous substance characterized by a capacitance and empirically derived, nonlinear conductances; however, the membrane is, in fact, inhomogeneous. Fig. 37 shows the detailed structure of membranes. The basic structure is a double layer of molecules called lipids. The layer is penetrated to varying depths by proteins. Fig. 38 shows the chemical composition of a lipid molecule. The tails of lipids are hydrophobic, that is, they repel water. It is this repulsion which largely holds the membrane together. Proteins are chains of amino acids, the formula for one of which is shown in Fig. 39. The residues  $R$  are chemical compounds such as thymine, cytosine, adenine, and guanine. The chains combine to form large varieties of proteins. By

one estimate, 50,000 different types are in the body, of which 100-3,000 have been documented. Fig. 40 shows some of the different proteins, separated according to gram molecular weight (*i.e.* the weight in grams of one mole, or  $6.02 \times 10^{23}$  molecules). It is seen that the range in weight is over an order of magnitude.

The proteins are important, electromagnetically, because they can conduct charges, while lipids are good insulators. Thus, proteins are the conductances  $g$  in the various equations and circuit models of the membrane. Exactly how current passes through proteins is not well understood, but the size and shape of the protein is almost certainly significant. If it somehow becomes bent or compressed, or if its site in the lipid layer is disrupted, then conduction is probably affected.

Electromagnetic fields can interact with proteins, possibly disturbing them as described above, over a wide range of frequencies. Between 1-10 MHz, depending on its size and mass, the entire protein may be regarded as a single dipole which rotates in response to an oscillating field. According to research physician David Straub (VA Hospital, Little Rock), if proteins are dislodged from their sites in membranes, much time passes until random motion restores them. Meantime, the conduction function performed by those proteins is interrupted. At high frequencies, individual parts of proteins may be regarded as dipoles. Many of these rotate in response to fields in the 10-20 GHz band.

Fig. 41 and Table 30 show additional responses of individual molecules to electromagnetic fields of various frequencies.

Proteins figure predominantly in at least one theory of cancer, advanced by Nobel laureate Albert Szent-Gyorgyi, which is currently being researched. According to this theory, proteins conduct electrons out of the cell interior. Oxygen molecules at the cell exterior accept the electrons and carry them away. These free electrons are products of some chemical process inside the cell that inhibits reproduction. If the electrons are not conducted away, then the process stops, and the cell divides at an uncontrolled rate. Eventually, there are enough cells to form a tumor, which

characteristically has a poor circulatory system. So, little or no oxygen-carrying blood reaches the cells. The continued lack of oxygen exacerbates the situation, and reproduction continues unchecked. This theory is consistent with and, in part, based upon evolution. The earliest living cells were cancerous in nature, reproducing without limit and they developed and thrived in the early atmosphere of this planet, which was oxygen starved.

As noted at the beginning of this section, theories exist for every geometric scale within the body. At one extreme, the entire body can be treated at once as a homogeneous object. Other theories focus on the cell. Still others concentrate on but a part of the cell, the membrane. Even the membrane is not homogeneous, and theories were presented based on one type of molecule within the membrane, the protein. Possibly, in an effort to better understand microscopic charge conduction, future theories will be specialized to certain chemical compounds within the protein.

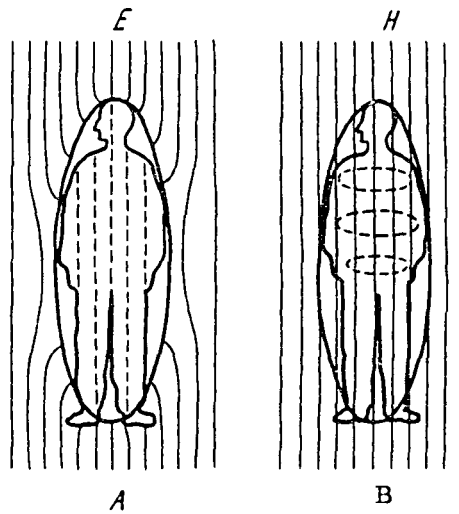

Human body (ellipsoid) in a uniform electric (A) and magnetic (B) field. The broken lines indicate the direction of the induced current.

FIG. 20. ELECTRIC CURRENT DENSITIES PRODUCED WHEN THE LONGITUDINAL AXIS OF THE HUMAN BODY IS PARALLEL TO ELECTRIC (E) AND MAGNETIC (H) FIELDS (FROM PRESMAN, 1970).

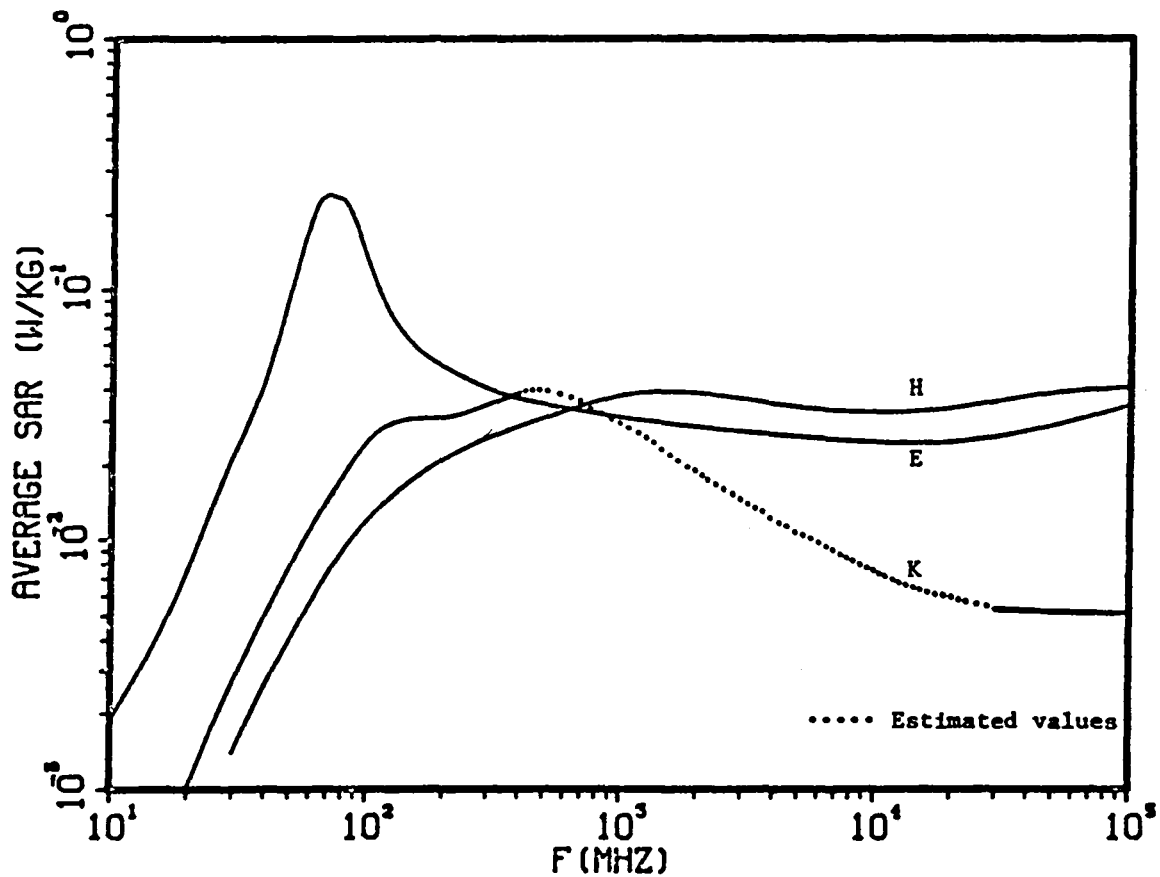

Calculated average SAR in a prolate spheroidal model of an average man for an incident power density of  $1 \text{ mW/cm}^2$  for three polarizations;  $a = 0.875 \text{ m}$ ,  $b = 0.138 \text{ m}$ ,  $V = 0.07 \text{ m}^3$ .

FIG. 21. POWER ABSORBED BY A HUMAN BODY IN THE FAR FIELD OF AN ELECTROMAGNETIC RADIATOR, FOR THREE DIFFERENT POLARIZATIONS. NOTE THAT THE LOW-FREQUENCY RESPONSE MIGHT BE VERY DIFFERENT IF THE BODY IS IN THE NEAR FIELD (FROM DURNEY ET AL, 1980).

Frequency (MHz)		10	20	50	60	80	100
SAR/BMR (%)	1 mW/cm <sup>2</sup>	0.13	0.6	5.8	16	16	12
	5 mW/cm <sup>2</sup>	0.65	3.0	29	80	80	60

Frequency (MHz)		200	500	1,000	2,000	5,000	10,000	20,000
SAR/BMR (%)	1 mW/cm <sup>2</sup>	5.2	3.7	2.9	2.5	2.5	2.5	2.5
	5 mW/cm <sup>2</sup>	26	18.5	14.5	12.5	12.5	12.5	12.5

TABLE 27. RATIO OF SAR (SPECIFIC ABSORPTION RATIO) TO BMR (BASAL METABOLIC RATE) FOR AN AVERAGE MAN EXPOSED TO A PLANE WAVE WITH A POWER DENSITY OF 1 MW/CM<sup>2</sup> AND 5 MW/CM<sup>2</sup> (FROM STUCHLY, 1978).

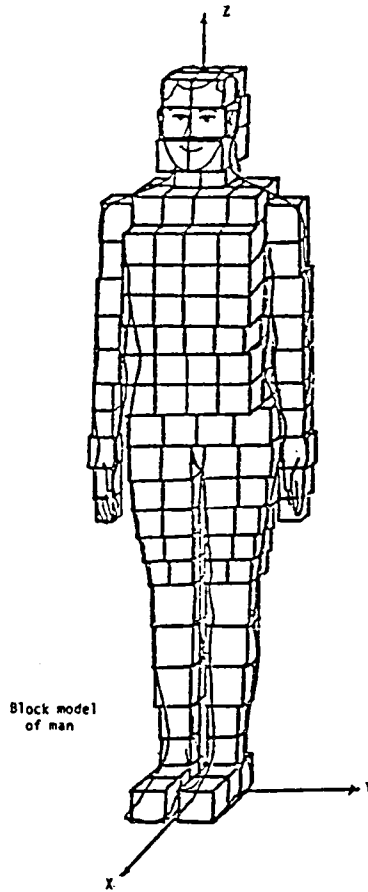
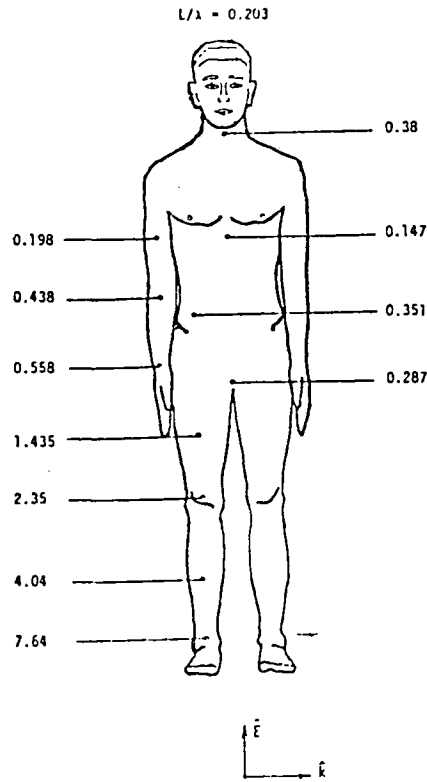

FIG. 22. MULTIPLE CUBE MODEL USED FOR DETAILED SAR COMPUTATIONS  
(FROM CHATTERJEE ET AL, 1980).





Distribution of power deposition for a human being with feet in electrical contact with the ground. The numbers are relative to whole-body-averaged SAR values of  $(1.75/L_m) \cdot 4.0$  W/kg for 10 mW/cm<sup>2</sup>.

FIG. 23. CALCULATED NONUNIFORM DISTRIBUTION OF DISSIPATED POWER (FROM GANDHI, 1980).

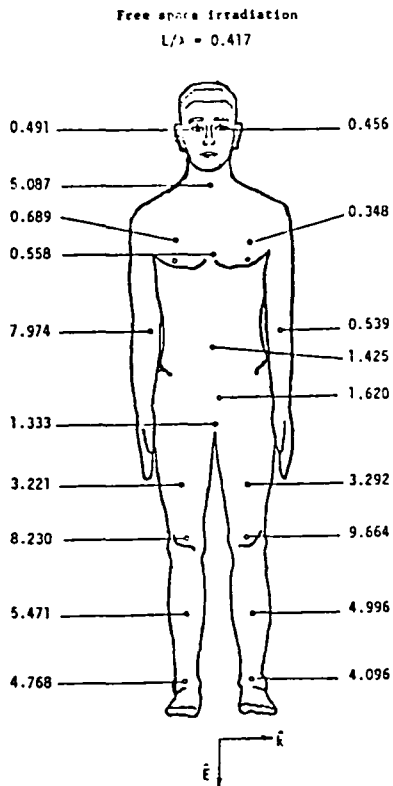

Distribution of power deposition for a human under free-space irradiation. The numbers indicated are relative to whole-body-averaged SAR of  $(1.75/L_m) \cdot 1.88$  W/kg for  $10 \text{ mW/cm}^2$  incident fields.

FIG. 24. CALCULATED NONUNIFORM DISTRIBUTION OF DISSIPATED POWER IN RESPONSE TO UNIFORM INCIDENT ELECTROMAGNETIC FIELD (FROM GANDHI, 1980).

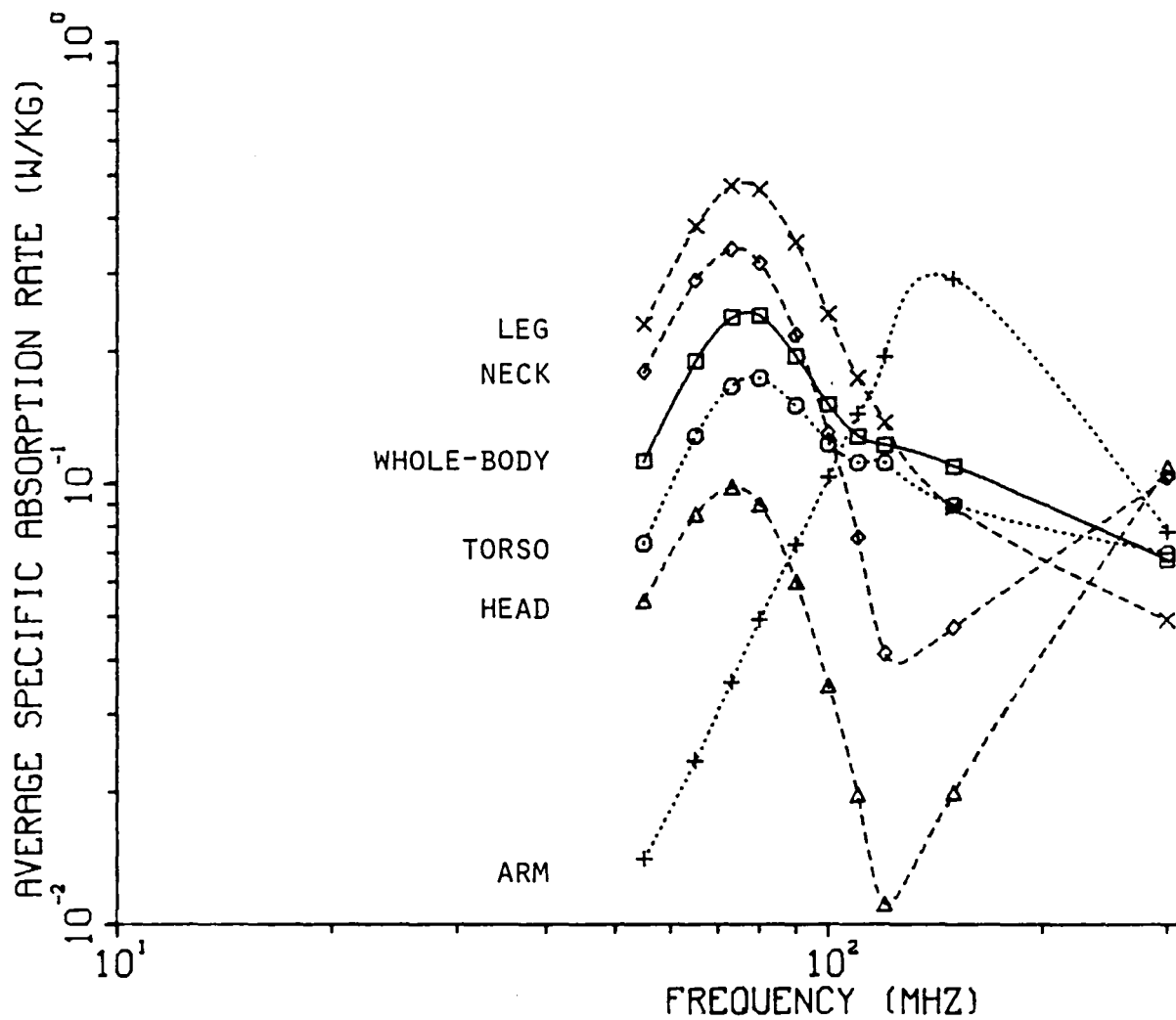

Part-body SAR for homogeneous model of man. Incident intensity =  $1 \text{ mW.cm}^2$ .

FIG. 25. DISSIPATED POWER AS A FUNCTION OF FREQUENCY IN VARIOUS PARTS OF THE HUMAN BODY (FROM TAYLOR & CHEUNG, 1977).

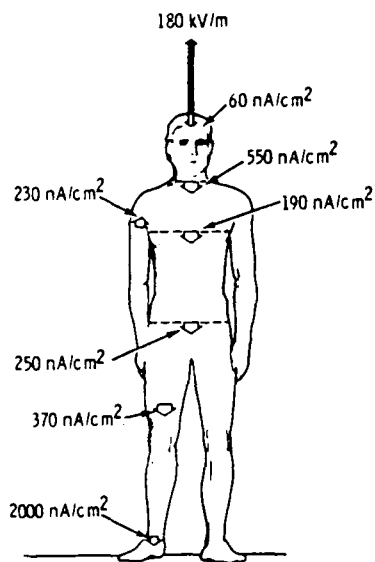

FIG. 26. CALCULATED CURRENT DENSITIES IN A GROUNDED MAN IN RESPONSE TO A 60-HERTZ, 10,000 VOLT/METER ELECTRIC FIELD (FROM KAUNE & PHILLIPS, 1980).

	Frequency (Mc)								
	25	50	100	200	400	700	1000	3000	8500
(a) Dielectric constant $\epsilon$									
Muscle	103-115	85-97	71-76	56	52-54	52-53	49-52	45-48	40-42
Heart muscle <sup>***</sup>				59-63	52-56	50-55			
Liver	136-138	88-93	76-79	50-56	44-51	42-51	46-47	42-43	34-38
Spleen	>200	135-140	100-101						
Kidney	>200	119-132	87-92	62	53-55	50-53			
Lung				35	35	34			
Brain	>160	110-114	81-83						
Fat		11-13		4.5-7.5	4-7		5.3-7.5	3.9-7.2	3.5-4.5
Bone marrow		6.8-7.7					4.3-7.3	4.2-5.8	4.4-5.4
(b) Conductivity $\kappa$ in mmho/cm									
Muscle		6.80-8.85		9.52-10.5	11.1-11.8	12.7-13.7	12.7-13.3	21.7-23.3	83.3
Heart muscle				8.7-10.5	10-11.8	10.5-12.8			
Liver	4.76-5.41	5.13-5.78	5.59-6.49	6.67-9.09	7.69-9.52	8.7-11.8	9.43-10.2	20-20.4	58.8-66.7
Spleen		6.62-7.81							
Kidney		6.9-11.1		11.1	11.8	1.3-1.32			
Lung		2.22-3.85		6.25	7.14	7.69			
Brain	4.55	4.76-5.26	5.13-5.56						
Fat		0.4-0.59		0.29-0.95	0.36-11.1		0.83-1.49	1.11-2.27	2.7-4.17
Bone marrow		0.2-0.36					0.43-1	1.16-2.25	1.67-4.76

(a) Values at 25, 50, and 100 MHz from Osswald (1937); at 200, 400, and 700 MHz from Schwan and Li (1953); at 1000, 3000, and 8500 MHz from Herrick *et al.* (1950). The values from 200 to 700 MHz have been obtained at 27°C and are adjusted to 37°C with the help of temperature coefficients discussed above.

TABLE 28. DIELECTRIC CONSTANT AND CONDUCTIVITY IN MMHO/CM OF VARIOUS BODY TISSUE AT 37 DEGREES CENTIGRADE (FROM SCHWAN & FOSTER, 1980).

Fat, Bone, and Tissues with Low Water Content									
Frequency (MHz)	Wavelength in Air (cm)	Dielectric Constant $\epsilon_L$	Conductivity $\sigma_L$ (mho/m)	Wavelength $\lambda_L$ (cm)	Depth of Penetration (cm)	Reflection Coefficient			
						Air-Fat Interface		Fat-Muscle Interface	
						$r$	$\phi$	$r$	$\phi$
1	30000								
10	3000								
27.12	1106	20	10.9-43.2	241	159	0.660	+174	0.651	+169
40.68	738	14.6	12.6-52.8	187	118	0.617	+173	0.652	+170
100	300	7.45	19.1-75.9	106	60.4	0.511	+168	0.650	+172
200	150	5.95	25.8-94.2	59.7	39.2	0.458	+168	0.612	+172
300	100	5.7	31.6-107	41	32.1	0.438	+169	0.592	+172
433	69.3	5.6	37.9-118	28.8	26.2	0.427	+170	0.562	+173
750	40	5.6	49.8-138	16.8	23	0.415	+173	0.532	+174
915	32.8	5.6	55.6-147	13.7	17.7	0.417	+173	0.519	+176
1500	20	5.6	70.8-171	8.41	13.9	0.412	+174	0.506	+176
2450	12.2	5.5	96.4-213	5.21	11.2	0.406	+176	0.500	+176
3000	10	5.5	110-234	4.25	9.74	0.406	+176	0.495	+177
5000	6	5.5	162-309	2.63	6.67	0.393	+176	0.502	+175
5900	5.17	5.05	186-338	2.29	5.24	0.388	+176	0.502	+176
8000	3.75	4.7	255-431	1.73	4.61	0.371	+176	0.513	+173
10000	3	4.5	324-549	1.41	3.39	0.363	+175	0.518	+174

Muscle, Skin, and Tissues with High Water Content									
Frequency (MHz)	Wavelength in Air (cm)	Dielectric Constant $\epsilon_H$	Conductivity $\sigma_H$ (mho/m)	Wavelength $\lambda_H$ (cm)	Depth of Penetration (cm)	Reflection Coefficient			
						Air-Muscle Interface		Muscle-Fat Interface	
						$r$	$\phi$	$r$	$\phi$
1	30000	2000	0.400	436	91.3	0.982	+179		
10	3000	160	0.625	118	21.6	0.956	+178		
27.12	1106	113	0.612	68.1	14.3	0.925	+177	0.651	-11.13
40.68	738	97.3	0.693	51.3	11.2	0.913	+176	0.652	-10.21
100	300	71.7	0.889	27	6.66	0.881	+175	0.650	-7.96
200	150	56.5	1.28	16.6	4.79	0.844	+175	0.612	-8.06
300	100	54	1.37	11.9	3.89	0.825	+175	0.592	-8.14
433	69.3	53	1.43	8.76	3.57	0.803	+175	0.562	-7.06
750	40	52	1.54	5.34	3.18	0.779	+176	0.532	-5.69
915	32.8	51	1.60	4.46	3.04	0.772	+177	0.519	-4.32
1500	20	49	1.77	2.81	2.42	0.761	+177	0.506	-3.66
2450	12.2	47	2.21	1.76	1.70	0.754	+177	0.500	-3.88
3000	10	46	2.26	1.45	1.61	0.751	+178	0.495	-3.20
5000	6	44	3.92	0.89	0.788	0.749	+177	0.502	-4.95
5800	5.17	43.3	4.73	0.775	0.720	0.746	+177	0.502	-4.29
8000	3.75	40	7.65	0.578	0.413	0.744	+176	0.513	-6.65
10000	3	39.9	10.3	0.464	0.343	0.743	+176	0.518	-5.95

TABLE 29. ELECTROMAGNETIC CONSTANTS AND RELATED PARAMETERS FOR VARIOUS TISSUES (FROM JOHNSON & GUY, 1972).

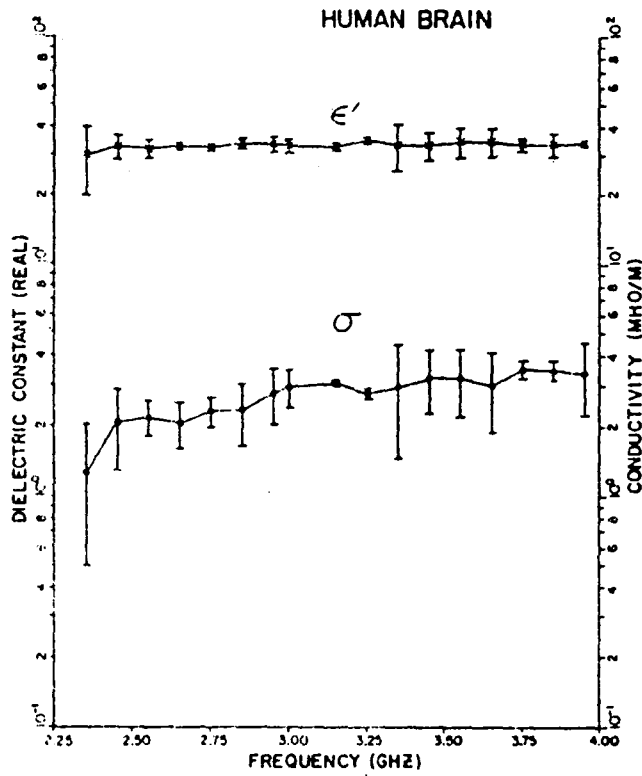

FIG. 27. DIELECTRIC PROPERTIES OF HUMAN BRAINS IN THE MICROWAVE S-BAND, AT 37 DEGREES CENTIGRADE (FROM LIN, 1975).

Gross Structure

- $\alpha$  - Excited membrane?  
Intracellular structure?
- $\beta$  - Tissue structure (Maxwell-Wagner)
- $\gamma$  - Water

Fine structure

- $\alpha_1$  - Charge transfer (ion relaxation)
- $\beta_1$  - Subcellular components, biologic macromolecules)
- $\delta$  - Bound  $H_2O$ , side chain rotation, amino acids

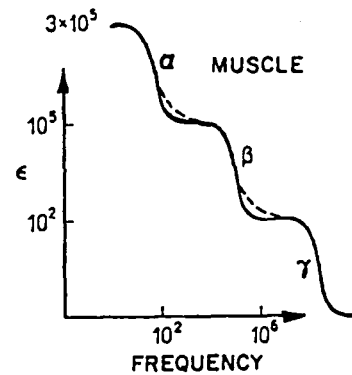

Gross and fine structural relaxation contribution to the dielectric constant of muscle tissue. Dashed lines indicate fine structural contributions. The data and various structural contributions are typical for all tissues of high water content. (From Schwan, 1974.)

FIG. 28. FREQUENCY DEPENDENCE OF MUSCLE TISSUE DIELECTRIC CONSTANT (FROM DWYER, 1978).



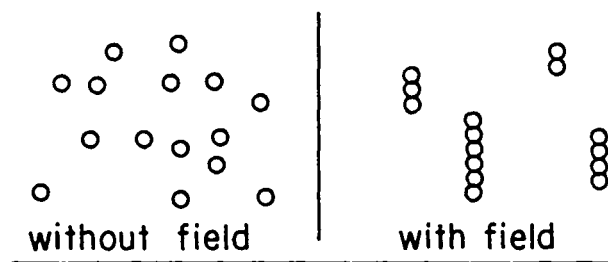
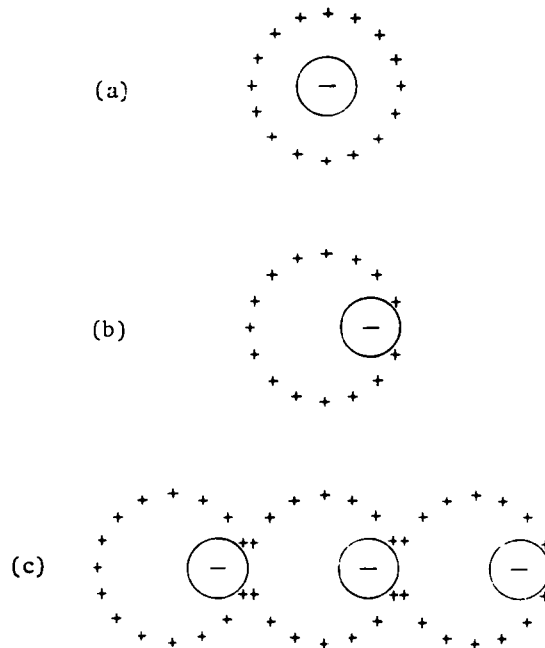
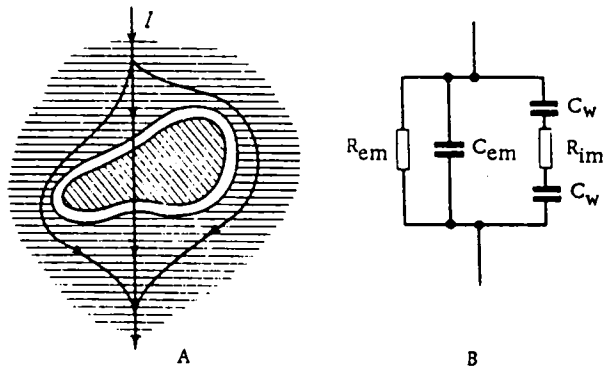

FIG. 29. PEARL CHAIN FORMATION (FROM STUCHLY, 1977).



(a) A negatively charged particle (-), together with a double (+) layer, forms an electrically neutral whole; (b) an induced dipole which arises when a charged particle enters an electrical field; (c) linking of oriented dipoles in the direction of an electrical field (chain formation).

FIG. 30. STEPS IN THE PROCESS OF PEARL CHAIN FORMATION (FROM MARHA & TUHA, 1971).



Passage of electric current ( $I$ ) in cell (A) and equivalent electric circuit of cell (B).  $R_{em}$  is the resistance and  $C_{em}$  is the capacitance of the extracellular medium.  $R_{im}$  is the resistance of the intracellular medium.  $C_w$  is the capacitance of the cell wall.

FIG. 31. ELECTRONIC CIRCUIT MODEL OF AN INDIVIDUAL CELL (FROM PRESMAN, 1970).

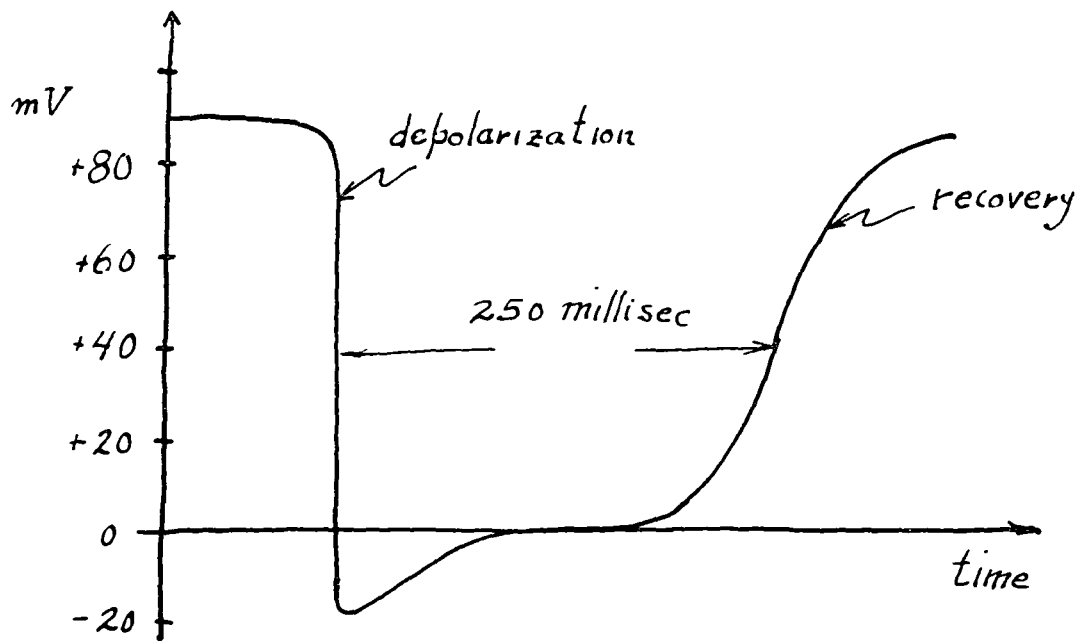

RECOVERY CURVE OR TRANSMEMBRANE ACTION POTENTIAL FOR A VENTRICULAR HEART MUSCLE CELL.

FIG. 32. VOLTAGE ACROSS THE MEMBRANE OF A HEART MUSCLE CELL (FROM BENEDEK & VILLARS, 1979).

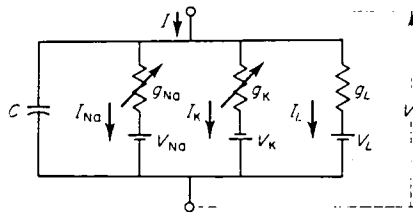

Equivalent circuit of the Hodgkin-Huxley model, showing three ionic pathways, for sodium, potassium, and leakage ions, and the membrane capacitor.

FIG. 33. HODGKIN-HUXLEY CIRCUIT MODEL FOR A CELL MEMBRANE (FROM SCHWAN, 1969).

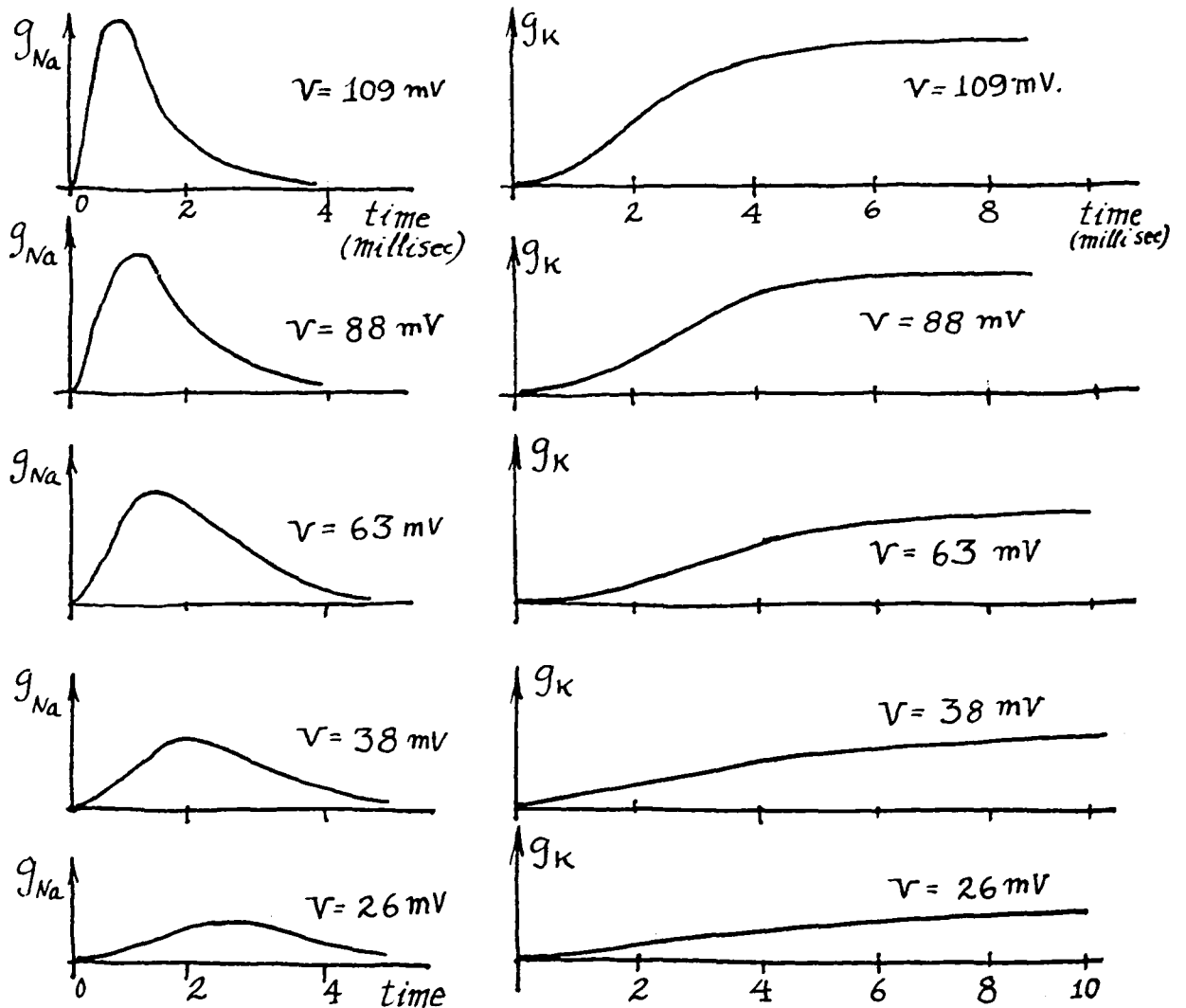
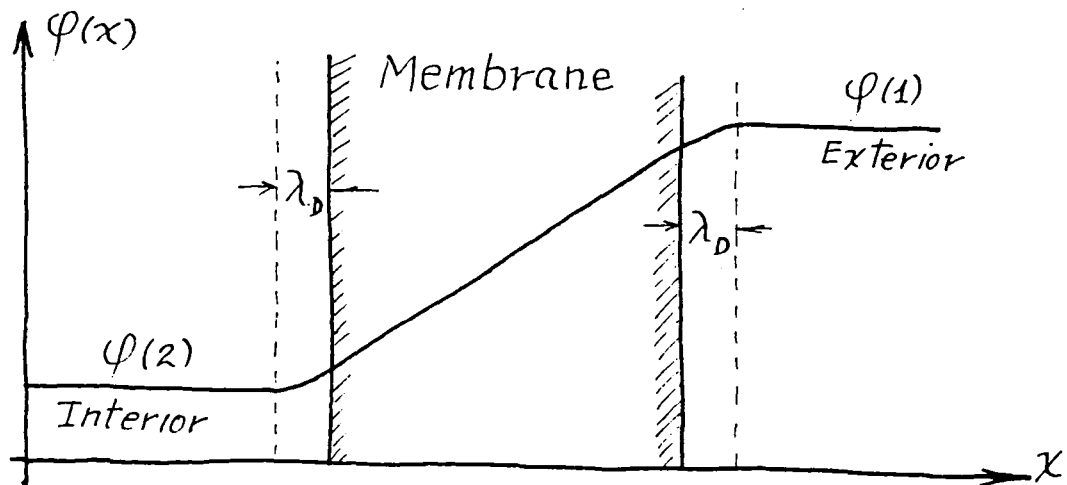
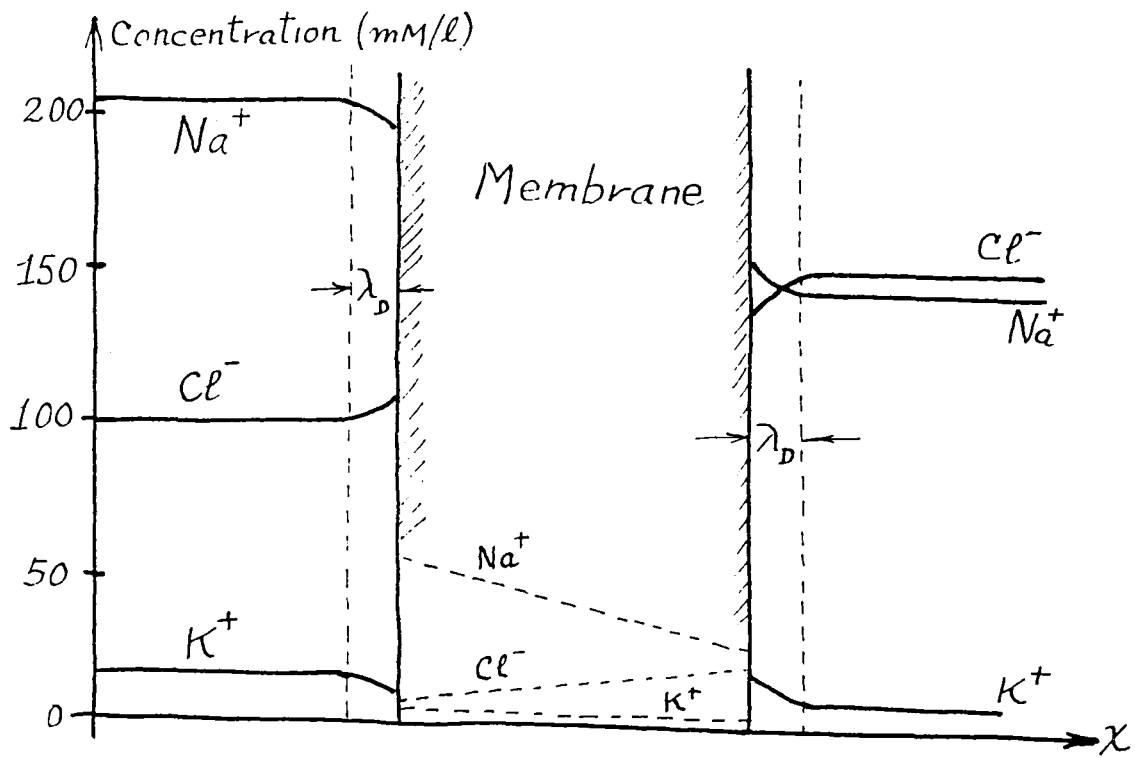

FIG. 3.3-20: TIME COURSE OF SODIUM AND POTASSIUM CONDUCTANCES FOLLOWING A DEPOLARIZATION STEP  $v$  AT  $t=0$ . CONDUCTANCE UNITS  $10^{-2}/\text{Ohm cm}^2$ . DEPOLARIZATION  $v$  IN MILLIVOLTS.

FIG. 34. TIME-DEPENDENT CONDUCTANCES IN THE CIRCUIT MODEL OF A CELL MEMBRANE. (FROM BENEDEK & VILLARS, 1979).



PROFILES OF IONIC CONCENTRATIONS AND ELECTRIC POTENTIAL ACROSS A BIOMEMBRANE, FOR THE DONNAN EQUILIBRIUM

FIG. 35. SIMILARITY OF CELL MEMBRANE TO SPACE CHARGE LAYER IN AN ELECTRONIC SEMICONDUCTING DEVICE (FROM BENEDEK & VILLARS, 1979).

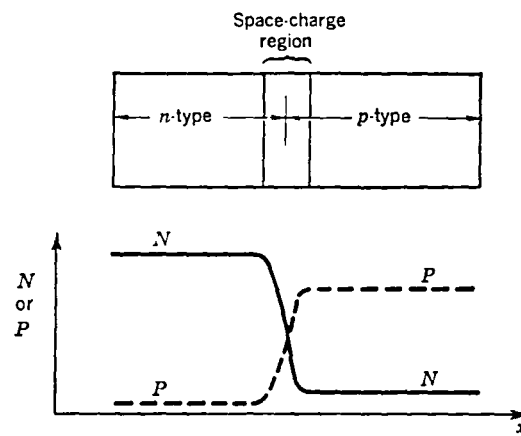

Hole and electron densities in a  $p$ - $n$  junction at thermal equilibrium.

FIG. 36. SPACE CHARGE LAYER IN A SEMICONDUCTOR.



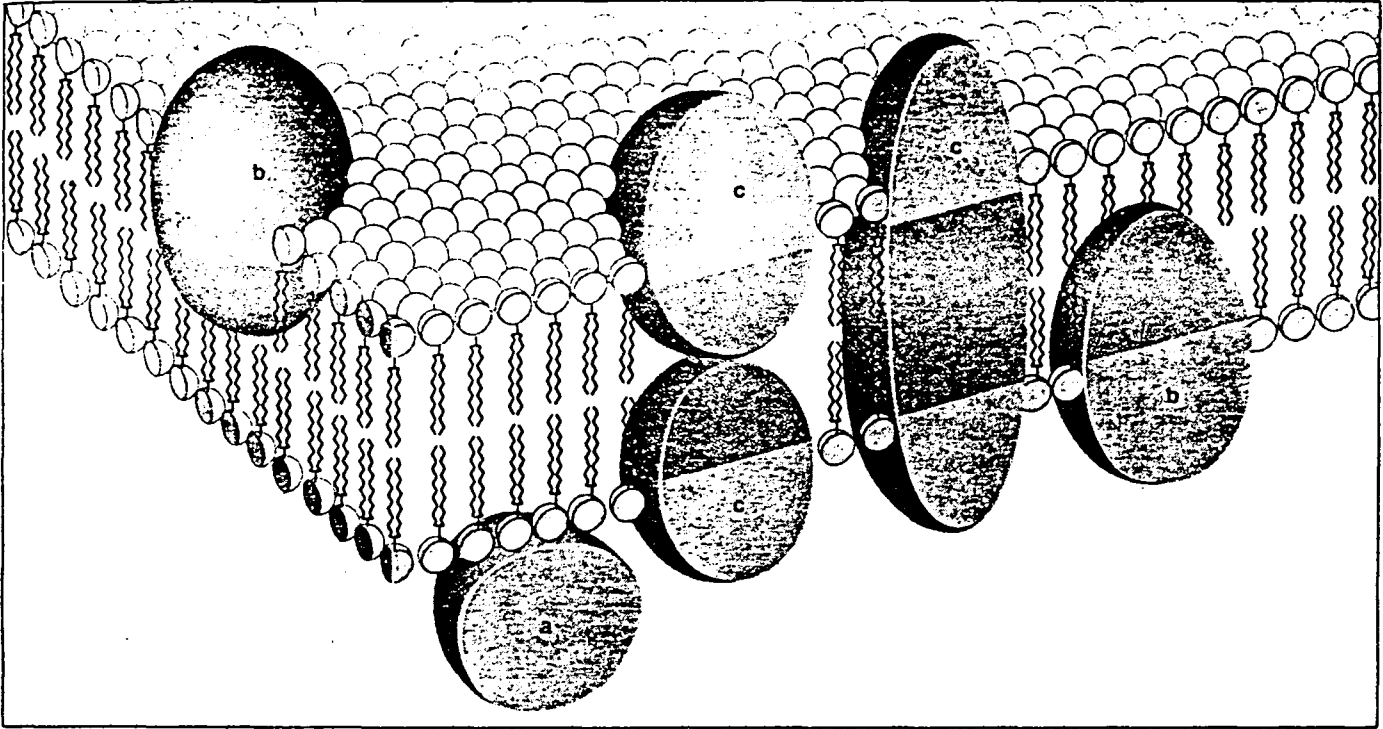

**STRUCTURAL FRAMEWORK** typical of cell membranes is made up of a bilayer of lipids with their hydrophilic heads forming outer and inner membrane surfaces and their hydrophobic tails meeting at the center of the membrane; the bilayer is about 45 ang-

stroms thick. Proteins, the other membrane constituents, are of two kinds. Some (a) lie at or near either membrane surface. The others penetrate the membrane; they may intrude only a short way (b) or may bridge the membrane completely (c), singly or in pairs.

**Lipid bilayer** containing membrane proteins. The proteins can serve as channels through the membrane for selected ions, as active trans-membrane pumps for specific molecules, as catalysts in chemical reactions, or as structural units in the membrane.

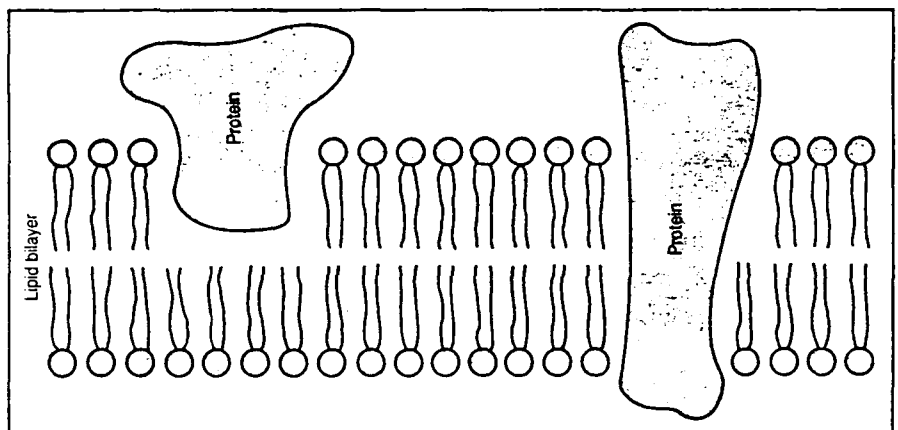

FIG. 37. LIPIDS AND PROTEINS IN A CELL MEMBRANE (ABOVE FROM CAPALDI, 1976, BELOW FROM CHANCE ET AL, 1980).

**AMPHIPATHIC STRUCTURE** of a lipid molecule, with a hydrophilic head and twin hydrophobic tails, is exemplified by this typical phospholipid, specifically a molecule of phosphatidylcholine. Various lipid molecules comprise about half of the mass of mammalian membrane, forming the membrane's structural framework. Their fatty-acid tails may be saturated (*left*), with a hydrogen atom linked to every carbon bond, or unsaturated (*right*), with carbons free.

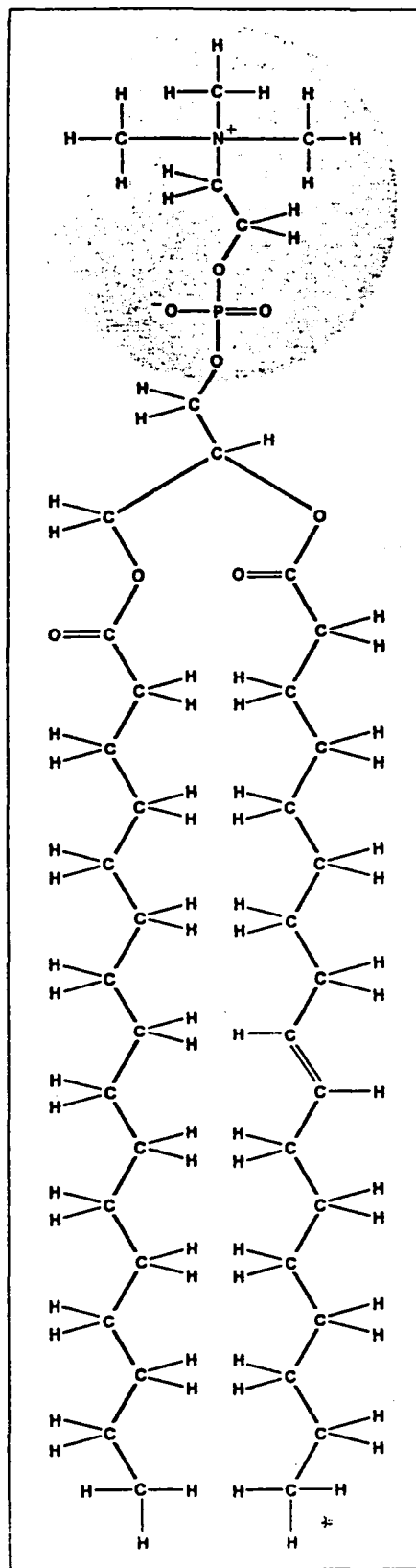
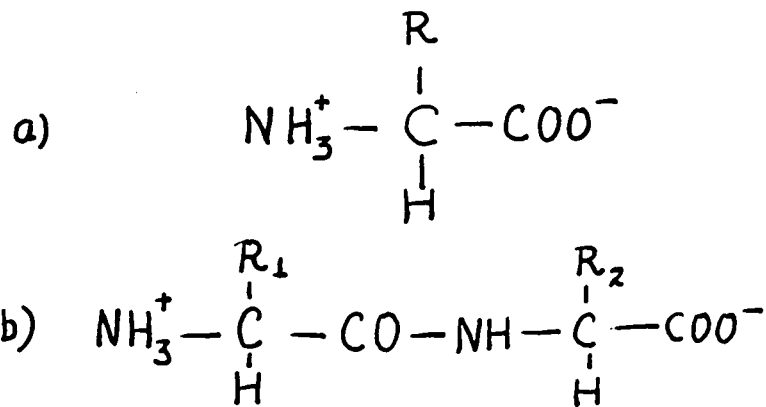
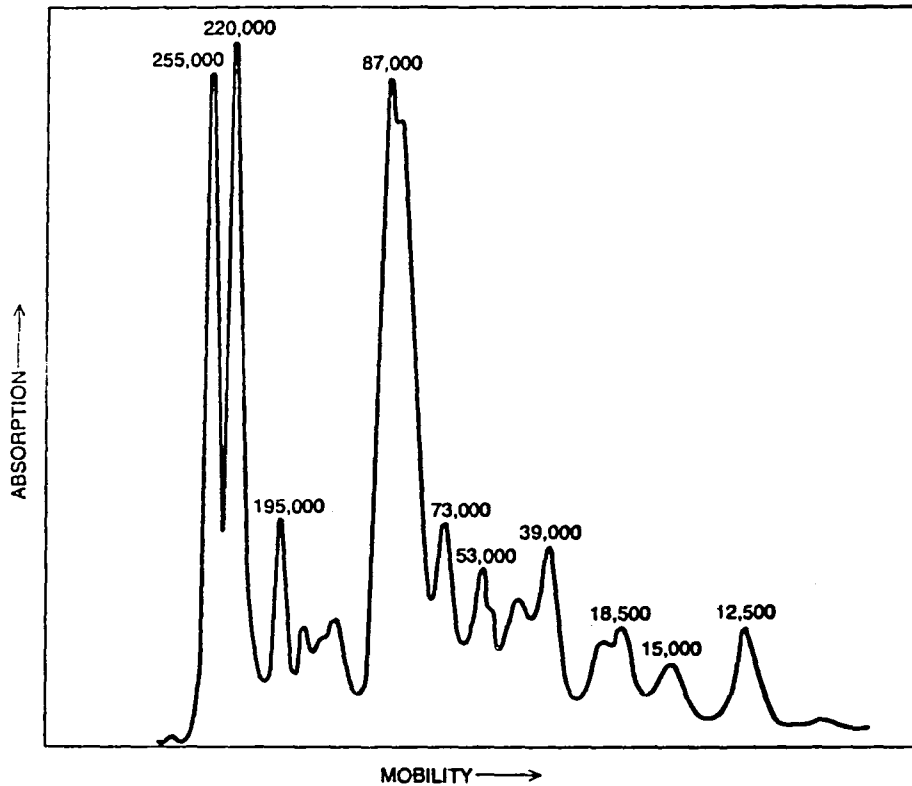

FIG. 38. CHEMICAL COMPOSITION OF A LIPID MOLECULE (FROM CAPALDI, 1976).



- a) SINGLE AMINO ACID. IN AQUEOUS SOLUTION THIS WILL GENERALLY EXIST AS A BIPOLAR ION ("ZITTERION"). R IS THE RESIDUE (see text).
- b) TWO AMINO ACIDS BONDED BY THE PEPTIDE BOND.

FIG. 39. CHEMICAL COMPOSITION OF AN AMINO ACID FROM WHICH PROTEINS ARE CONSTRUCTED (FROM BENEDEK & VILLARS, 1979).



IDENTITY OF PROTEINS in the membrane of red blood cells can be determined by means of gel electrophoresis. In this instance the proteins have been stained and scanned, using a densiometer, after those with the lowest molecular weights have migrated farthest through the gel in response to an electric potential. The two proteins with the highest molecular weight (*left*) form the dimer collectively called spectrin. The scan shows at least 10 more absorption bands signifying the presence of other proteins even lower in weight.

FIG. 40. WIDE RANGE OF MOLECULAR WEIGHTS FOR VARIOUS PROTEINS (FROM CAPALDI, 1976).

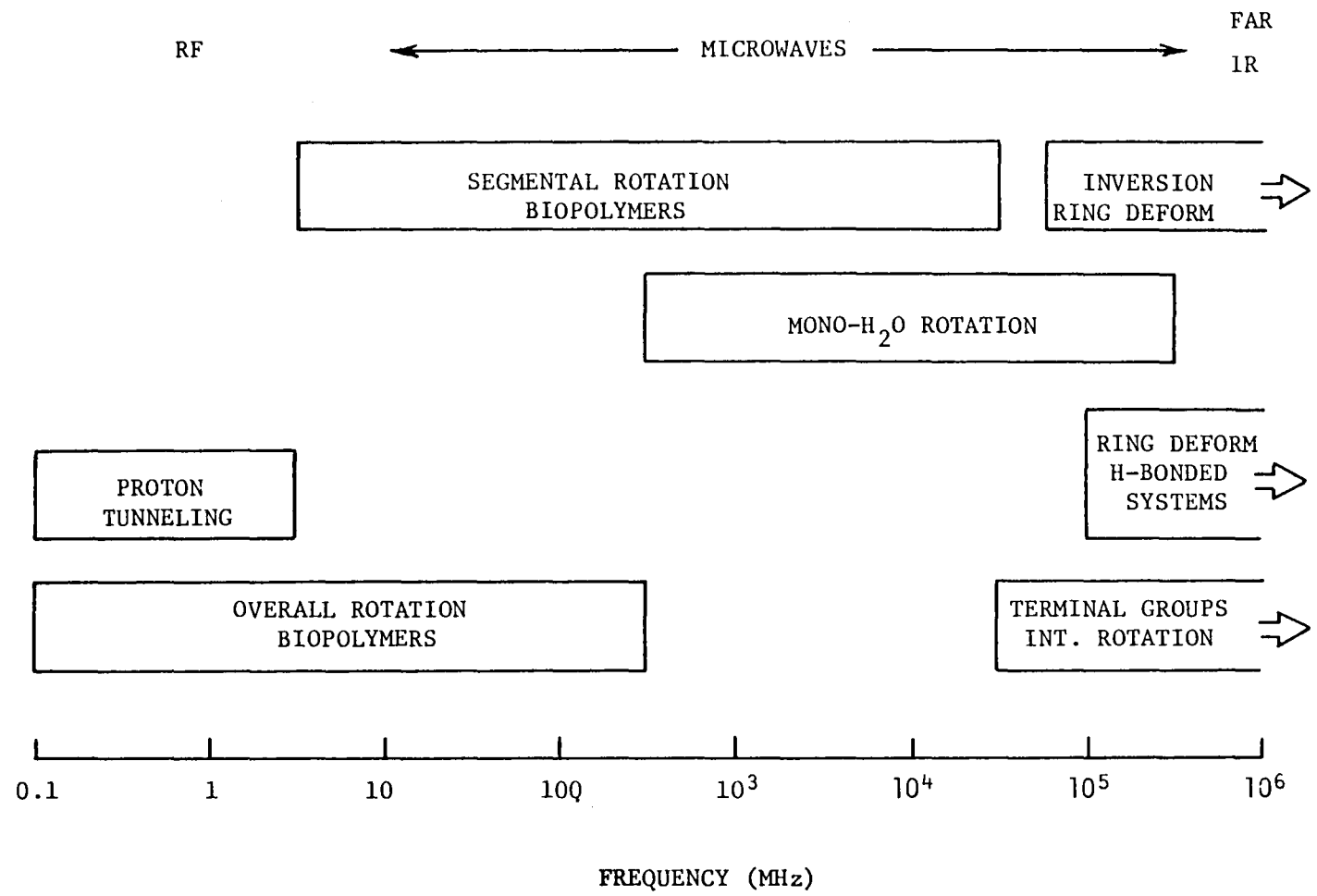

93.

FIG. 41. SOME MOLECULAR RESPONSES TO ELECTROMAGNETIC RADIATION (FROM STUCHLY, 1977).

RESEARCHER	SUBSTANCE	FREQUENCY	EFFECT
Prohofsky	DNA helix	100 GHz	Conformational change from A to B.
Prohofsky	DNA helix	430 MHz	Bases pulled apart.
McCammon	DNA helix	2 GHz	Rippling motions, or traveling wave displacements.

TABLE 30. MOLECULAR CHANGES CITED BY TAYLOR, 1979.

## Some Speculation and Areas for Further Research

Based on the exhibits and discussions of the preceding sections, the present state of knowledge would most likely benefit from the following types of efforts:

- Improved observations of effects
- More intensive, quantitative exploitation of existing physiological knowledge and electromagnetic theory.
- Formulation of new physio-electromagnetic theories.

Elaboration on these follows.

### *Improved Observations of Effects*

The need for more uniform and rigorous reporting is especially evident in the section concerning adverse effects. Precise records of frequency, polarization, intensity, and duration of exposure are sometimes lacking. Quantitative measures of the effect (*e.g.* how severe, how extensive, how persistent) are similarly lacking. A standard procedure for conducting formal epidemiological studies is needed, including precise definitions of the electromagnetic variables and biological endpoints.

In contrast, beneficial effects, especially electromagnetic diathermy and hyperthermia, have been exploited in a much more purposeful fashion. The reason is probably that at least the desired biological endpoint (selective, localized heating) was clear. On the other hand, identification and optimization of electromagnetic variables is still in progress.

A sound theoretical foundation would certainly clarify the variables and endpoints.

### *Quantitative Exploitation of Existing Physiological Knowledge*

The preceding section indicated that the properties and functions of the human body have been investigated at many levels of detail, ranging from the bulk properties of organs and tissue to the structure

of cell membranes and proteins. This knowledge has already been the basis for some rigorous computations, but many more are still waiting to be performed. Among those already demonstrated, the SAR concept, discussed in the preceding section, has been highly refined. Computer models can predict heat dissipation and temperature changes for local regions of the body.

On the other hand, no computation has yet been performed to determine the current density incident at the membrane of individual cells *in situ* for heart muscles or nerves due to external electromagnetic fields. Such a computation might be practical, and it could provide much quantitative information concerning the effects of frequency, polarization, intensity, and other variables on the functioning of these cells. The computation might be further extended to include arrays of cells to determine whether they respond coherently.

#### *New Physio-Electromagnetic Theories*

Some novel interactions between electromagnetic fields and the human body have been proposed, and they await further investigation, both theoretically and experimentally. The ones discussed here include: nonionizing single photon interactions, coherent phenomena, coupled oscillators, and the relative importance of different charge species.

As noted in the introduction of this report, single photon interactions other than ionization are expected, based on fundamental physics. In principle, external electromagnetic fields can cause an abnormal response if the energy per photon is greater than the background, or thermal, noise due to others encountered randomly within the human body. The energy of a randomly encountered photon is, on the average:

$$E = kT \tag{19}$$

where  $k = 1.381 \times 10^{-23}$  joules/degree and  $T$  is temperature in degrees Kelvin. For a body temperature of about  $300^{\circ}$ ,  $E$  is about 0.025 eV, or about 500 times less than the standard definition for ionizing radiation. Using eq. 1, the equivalent frequency is about 6,000 GHz,



or about 500 times lower than the arbitrary minimum frequency for ionizing radiation. Table 31 lists some of the single photon interactions that are expected. Fig. 42 shows the ratio of photon energy to  $kT$  for the lower part of the electromagnetic spectrum.

After investigating single photon interactions, it would be logical to consider the possibility of multiple photon interactions. If one photon can alter a protein at 6,000 GHz, then 6,000 photons can do it at 1 GHz. But how efficiently can one protein intercept 6,000 1-GHz photons? What would the corresponding incident field intensity be at the surface of the body? Would it be so great that thermal injury would overwhelm the interaction?

The answer, that is, the field intensity, might be surprisingly low. The concept of cooperative, or long-range, or coherent, interactions suggests this result. According to the concept, individual microscopic particles, such as proteins, can have very large cross sections (*i.e.* receiver areas or gain) if they interact with each other. Actually, this is not such a novel idea. High gain antennas and lasers are established examples. In electromagnetic physiology, however, only a few theories based on it have appeared so far.

According to one such theory, proposed by Frohlich, the surface charges on a cell membrane are all coherent. Further, they may also be coherent with surface charges on the membranes of other cells. All of these charges, considered collectively, can oscillate between at least two different states. Based on quantum mechanical formulas, Frohlich has estimated the natural frequency of oscillation. It is in the band 50-3,000 GHz.

Frohlich suggests his theory may lead to a better understanding of cancer. The energy required to sustain the oscillations comes from within the cells. The energy drain inhibits cell reproduction. If the oscillations cease, then the cell divides without bound, ultimately resulting in cancer. This implies that electromagnetic waves in the 50-3,000 GHz band might promote or be used to inhibit the disease.

According to another theory, charges and currents in the brain and central nervous system are also coherent. They are, therefore, sensitive to very low level external fields.

In the preceding section, microscopic parts of the body were modelled as various circuit elements, including capacitors, conductances, and rectifying junctions. The theories just described suggest that further modeling might be useful in terms of high gain antennas. Practical antennas today achieve gains of 30 dB or more. If biological antennas have similar gains, how would that affect the body's sensitivity to electromagnetic fields?

Another, perhaps related, concept that could be further explored is coupled oscillators. This has been partially developed for at least one part of the human body, the gastro-intestinal system. It is rich in low-frequency electrical signals, as indicated by Figs. 43 and 44. From Fig. 44, it is seen that the waveforms are not sinusoidal. They are called "limit cycles". Limit cycles are solutions to the Van der Pol equation, which is of the form,

$$\frac{\partial^2 x}{\partial t^2} - \epsilon (a^2 - x^2) \frac{\partial x}{\partial t} + \omega^2 x = 0 \quad (20)$$

The observed gastro-intestinal signals have been reproduced using a model made of coupled Van der Pol oscillators. Fig. 45 shows such a model. The preceding section described the currents across individual cell membranes associated with the action potentials of nerves and muscles. What currents might be required to excite a large system of coupled oscillators?

Little distinction has so far been made between species of electric currents. In fact, however, it is probably significant. The flow of sodium currents probably has a different effect than the flow of proton currents or calcium currents. What other species of currents are found within the body, and what are their different physiological functions? The answer might be found in the detailed structure and conduction mechanisms of the many different proteins embedded in cell membranes. This level of microscopic detail is now the frontier of understanding for the human body. The frontier awaits exploration.

EFFECT	ACTIVATION ENERGY (eV)	CORRESPONDING FREQUENCY (GHz)
Thermal Motion (at 30°C)	0.026	$6.3 \times 10^3$
Ionization	10	$2.4 \times 10^6$
Covalent bond disruption	5	$1.2 \times 10^6$
London-van der Waals interactions	1	$2.4 \times 10^5$
Hydrogen bond disruption	0.08 - 0.2	$1.9 \times 10^4 - 4.8 \times 10^4$
Disruption of bound water	0.56	$1.4 \times 10^5$
Reversible conformational changes in protein molecules	0.4	$9.7 \times 10^4$
Charge transfer interaction	3 - 6	$7.3 \times 10^5 - 1.45 \times 10^6$
Semiconduction	1 - 3	$2.4 \times 10^5 - 7.25 \times 10^5$

TABLE 31. ACTIVATION ENERGY OF MOLECULAR EFFECTS IN BIOLOGICAL SYSTEMS (FROM STUCHLY, 1977).

Region of Electromagnetic Spectrum from Infralow to Superhigh Frequencies,  
in Which  $h\nu < kT$

Wave ranges	Low-frequency waves										Radio waves					Ultraradio waves				
											Microwaves					Long	Medium	Inter- mediate	Short	Meter
Wavelength, cm	$10^{13}$	$10^{12}$	$10^{11}$	$10^{10}$	$10^9$	$10^8$	$10^7$	$10^6$	$10^5$	$10^4$	$10^3$	$10^2$	10	1	0,1	0,01				
Frequency, Hz	$3 \cdot 10^{-3}$	$3 \cdot 10^{-2}$	$3 \cdot 10^{-1}$	3	$3 \cdot 10^1$	$3 \cdot 10^2$	$3 \cdot 10^3$	$3 \cdot 10^4$	$3 \cdot 10^5$	$3 \cdot 10^6$	$3 \cdot 10^7$	$3 \cdot 10^8$	$3 \cdot 10^9$	$3 \cdot 10^{10}$	$3 \cdot 10^{11}$	$3 \cdot 10^{12}$				
$h\nu/kT$	$4,5 \cdot 10^{-18}$					$4,5 \cdot 10^{-9}$					$4,5 \cdot 10^{-5}$					0,45				
Frequency ranges	Infra- low	Low	Industrial	Audio	High (HF)	Ultrahigh (UHF)					Superhigh (SHF)									

FIG. 42. ELECTROMAGNETIC SPECTRUM, WITH EMPHASIS ON ENERGY PER PHOTON (FROM PRESMA, 1970).

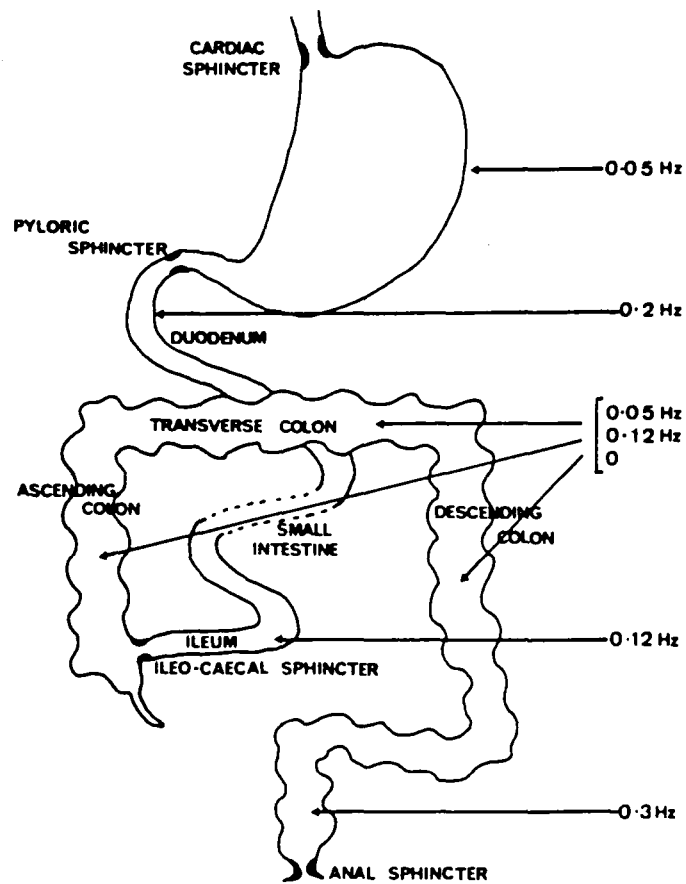
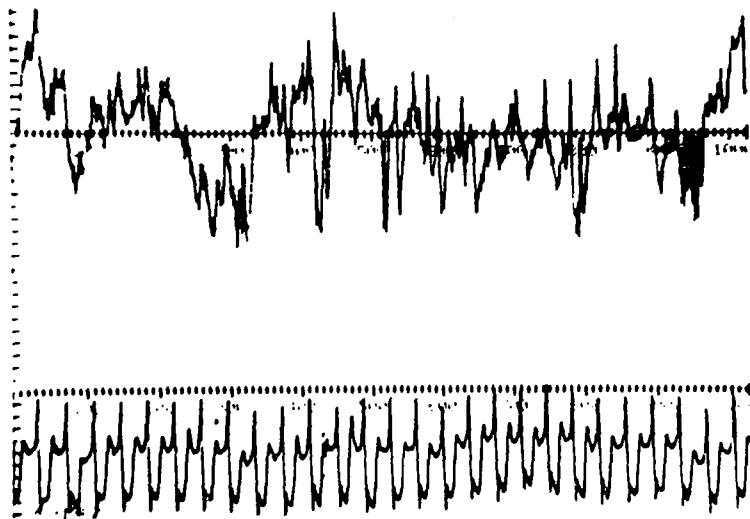

FIG. 43. DIGESTIVE TRACT DIAGRAM INCLUDING TYPICAL SLOW-WAVE FREQUENCIES (FROM LINKENS, 1979).



*Recording of human gastric electrical activity. Top trace is from a surface electrode, bottom trace is from an internal electrode*

FIG. 44. LIMIT CYCLE TYPE WAVEFORMS OBSERVED IN HUMAN DIGESTIVE TRACT (FROM LINKENS, 1979).

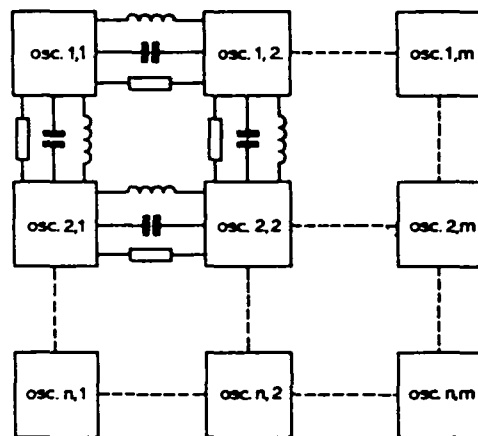

FIG. 45. TWO-DIMENSIONAL COUPLED OSCILLATOR STRUCTURE FOR DIGESTIVE TRACT MODELLING.

## Acknowledgments

The author is indebted to a number of individuals at the NASA Goddard Space Flight Center for their enthusiastic support. Mr. Tom Golden, Director of Technology Transfer, National Needs Office, participated in many helpful and inspiring discussions, and he was instrumental in realizing a series of telephone interviews which reached across the United States. Ms. Adelaide del Frate and Ms. Jane Riddle performed numerous literature searches and tirelessly pursued documents which were difficult to obtain. Mr. John Fuchs translated documentation which was available only in German.

Prof. Augustine Cheung, Dept. of Molecular Physics, University of Maryland, gave generously of his time and technical library, during at least two in-person interviews. Prof. Leonard Taylor, of the same department, delivered an informative lecture on biological effects and directed the author towards useful references.

Sally Faith Dorman, MD, MSHSA, Center for Disease Control, Atlanta, identified and provided a number of obscure documents which proved to be a wealth of pertinent information.

A number of exceptional professionals gave generously of their time via telephone interviews, which in some instances continued for nearly three hours without interruption. The author is very grateful to: Dr. Joseph C. Sharp, Director of Life Sciences, NASA, Ames Research Center; Prof. William Guy, Dept. of Rehabilitation Medicine, University of Washington, Seattle; David Straub, MD, Veteran's Administration, Little Rock; Peter Gascoyne, Ph.D., National Foundation for Cancer Research, Woods Hole, Massachusetts; Robert MacElroy, Ph.D., NASA, Ames Research Center; and Prof. Charles Pouvaris, Dept. of Electrical Engineering, Catholic University. To enumerate their individual contributions would easily fill a large report. In fact, they largely filled this one.

Helpful article reprints were thoughtfully provided by Ross Adey, MD, Veteran's Administration, Loma Linda, and by Stephanie Seidman, Ph.D., NIH, Bethesda, Maryland.



## References

1. Barret & Myers, "Microwave Thermography of Normal and Cancerous Breast Tissue," Preprint to be published in *Annals of the New York Academy of Sciences*.
2. Benedek & Villars, *Physics With Illustrative Examples from Medicine and Biology, Vol. 3: Electricity and Magnetism*, Addison-Wesley, 1979.
3. Capaldi, "A Dynamic Model of Cell Membranes," *Scientific American*, March, 1976, pp. 27-33.
4. Chance, Mueller, de Vault & Powers, "Biological Membranes," *Physics Today*, Oct. 1980, pp. 32-38.
5. Chatterjee, Hagmann & Gandhi, "Electromagnetic Energy Deposition in an Inhomogeneous Block Model of Man for Near Field Irradiation Conditions," *IEEE Trans. on Microwave Theory and Techniques*, Dec. 1980, pp. 1452-1459.
6. Danzer, Hollman, Rajewsky, Schaefer & Schliephake, *Ultrakurzwellen in ihren Medizinisch-Biologischen Anwendungen*, Leipzig: Georg Thieme, 1938.
7. David, "A Study of Federal Microwave Standards," *DOE Rept. ER-10041-02*, August, 1980.
8. Durney, Iskander, Massoudi, Allen & Mitchell, "Radiofrequency Radiation Dosimetry Handbook, Third Edition," *USAF School of Aerospace Medicine Rept. SAM-TR-80-32*, August, 1980.
9. Dwyer & Leeper, "A Current Literature Report on the Carcinogenic Properties of Ionizing and Nonionizing Radiation," *DHEW Publication (NIOSH) 78-134*, March, 1978.
10. Frazier, "An Evaluation of Health and Environmental Effects of Extra High Voltage (EHV) Transmission, First Interim Report," Chicago: *ITT Research Institute Report*, May, 1978.
11. Gandhi, "State of the Knowledge for Electromagnetic Absorbed Dose in Man and Animals," *Proc. IEEE*, Jan. 1980, pp. 24-40.
12. Johnson & Guy, "Nonionizing Electromagnetic Wave Effects in Biological Materials and Systems," *Proc. IEEE*, June, 1972, pp. 692-718.
13. Johnson & Shore (eds.) "Biological Effects of Electromagnetic Waves, Vol. I," *HEW Publication (FDA) 77-8010*, Dec. 1976.
14. Johnson & Shore (eds.) "Biological Effects of Electromagnetic Waves, Vol. II" *HEW Publication (FDA) 77-8011*, December, 1976.

15. Kaune & Phillips, "Comparison of the Coupling of Grounded Humans, Swine, and Rats to Vertical, 60-Hz Electric Fields," *Bioelectromagnetics* 1:2, 1980, pp. 117-130.
16. Kleinstein & Dyner (eds.) *Biological Effects of Nonionizing Electromagnetic Radiation 1976-1980*, Philadelphia: The Franklin Institute, 1980.
17. Lerner, "RF Radiation: Biological Effects," *IEEE Spectrum*, Dec. 1980, pp. 51-59.
18. Lin, "The Microwave Auditory Phenomenon," *Proc. IEEE*, Jan. 1980, pp. 67-73.
19. Lin, "Microwave Properties of Fresh Mammalian Brain Tissue at Body Temperature," *IEEE Trans. on Biomedical Engineering*, Jan. 1975, pp. 74-76.
20. Linkens (ed.) *Biological Systems, Modelling and Control*, Stevenage, UK: Peter Peregrinus, 1979.
21. Marha, Musil & Tuha, *Electromagnetic Fields and the Life Environment*, San Francisco Press, 1971.
22. McCree, "Soviet and Eastern European Research on Biological Effects of Microwave Radiation," *Proc. of IEEE*, Jan. 1980, p-. 84-91.
23. Persinger (ed.), *ELF and VLF Electromagnetic Field Effects*, New York: Plenum Press, 1974.
24. Presman, *Electromagnetic Fields and Life*, New York: Plenum Press, 1970.
25. Schwan (ed.) *Biological Engineering*, McGraw-Hill, 1969.
26. Schwan & Foster, "RF Field Interactions With Biological Systems: Electrical Properties and Biophysical Mechanisms," *Proc. IEEE*, Jan. 1980, pp. 104-114.
27. Short & Turner, "Physical Hyperthermia and Cancer Therapy," *Proc. IEEE*, Jan. 1980, pp. 133-142.
28. Sterzer, Paglione, Mendecki, Friedenthal & Botstein, "RF Therapy for Malignancy," *IEEE Spectrum*, Dec. 1980, pp. 32-37.
29. Stuchly, "Health Aspects of Radio Frequency and Microwave Radiation Exposure, Part 1," Ottawa, Canada: *Dept. of National Health and Welfare Rept. 77-EHD-13*, Nov. 1977.
30. Stuchly, "Health Aspects of Radio Frequency and Microwave Radiation Exposure, Part 2," Ottawa, Canada: *Dept. of National Health and Welfare Rept. 78-EHD-22*, March, 1978.

31. Taylor & Cheung (eds.), *The Mechanisms of Microwave Biological Effects*, University of Maryland Publication, May, 1979.
32. Taylor & Cheung (eds.) "The Physical Basis of Electromagnetic Interactions With Biological Systems," *HEW Publication (FDA) 78-8055*, April, 1978.
33. Tyler (ed.) "Biological Effects of Nonionizing Radiation," *Annals of the New York Academy of Sciences*, Vol. 247, Feb. 28, 1975.
34. Valentino, "Environmental Assessment for the Satellite Power System (SPS) Concept Development and Evaluation Program (CDEP)" *DOE Rept. ER-0069*, August, 1980.
35. Wertheimer & Leeper, "Electrical Wiring Configuration and Childhood Cancer," *American Journal of Epidemiology*, 1979, pp. 273-84.
36. --- "Death By Microwave?" *Bioelectromagnetics Society Newsletter*, Dec. 1980, p. 1.
37. --- "Draft Environmental Impact Statement for PAVE PAWS System at Otis Air Force Base, Massachusetts," *USAF Report*, Dec. 1978.

## Bibliography

38. Abramson, Moyer & Gorin, *Electrophoresis of Proteins and the Chemistry of Cell Surfaces*, New York: Reinhold Publishing, 1942.
39. Adey, "Models of Membranes of Cerebral Cells As Substrates for Information Storage," *BioSystems*, 8 (1977), pp. 163-78.
40. Adey, "Neurophysiologic Effects of Radiofrequency and Microwave Radiation," *Bulletin of the New York Academy of Medicine*, Dec: 1979, pp. 1079-1093.
41. Arthur (ed.) "Proceedings of the 1978 Electromagnetic Interference Workshop," *NBS Special Publication No. 551*, July, 1979.
42. Becker, "The Significance of Bioelectric Potentials," *Biochemistry and Bioenergetics*, 1 (1974), pp. 187-199.
43. Beischer, "Human Tolerance to Magnetic Fields," *Astronautics*, March, 1962, p. 24.
44. Benedick, "Blood-Brain Barrier Workshop," Chicago: *IIT Research Institute Rept.* May, 1979.
45. Browne, "Benign Radiation Increasingly Cited As Dangerous," *New York Times*, Oct. 21, 1980.
46. Cain, "A Theoretical Basis for Microwave and RF Field Effects on Excitable Cellular Membranes," *IEEE Transactions on Microwave Theory and Techniques*, Feb. 1980, pp. 142-147.
47. Chou & Guy, "Holographic Assessment of Microwave Hearing," *Science*, Sept. 5, 1980, pp. 1143-5.
48. Dodge, *Workshop on Mechanisms Underlying Effects of Long-term, Low-level, 2450 MHz Radiation on People, Semi-Final Draft*, Science Policy Research Division, Congressional Research Service, Library of Congress, Sept. 5, 1980.
49. Duke & Schein, "Organic Solids: Is Energy-Band Theory Enough?" *Physics Today*, Feb. 1980, pp. 42-48.
50. Edmonds, "Making (Micro)waves over Trade Center TV," *New York: Daily News*, Feb. 25, 1980, p. 1.
51. Emery, Short, Guy, Kraning & Lin, "The Numerical Thermal Simulation of the Human Body When Undergoing Exercise or Nonionizing Electromagnetic Irradiation," *Trans. of the ASME*, May, 1976, pp. 284-291.
52. French, "Can Ion Device Make Magic, Or Just Profits?" *Wall Street Journal*, Oct. 8, 1980.

53. Frohlich, "Bose Condensation of Strongly Excited Longitudinal Electric Modes," *Physics Letters*, March 25, 1968, pp. 402-403.
54. Frohlich, "Coherent Electric Vibrations in Biological Systems and the Cancer Problem," *IEEE Trans. on Microwave Theory and Techniques*, Aug. 1978, pp. 613-617.
55. Glaser, Brown & Brown, "Bibliography of Reported Biological Phenomena ("Effects") and Clinical Manifestations Attributed to Microwave and Radio-Frequency Radiation: Compilation and Integration of Report and Seven Supplements," *Naval Medical Research Institute Rept.*, Sept. 1976.
56. Graham, "Electric Stimulators Heal Bones, Show Potential for Other Cures," *The Wall Street Journal*, July 11, 1980, p. 11.
57. Guy, Webb & McDougall, "RF Radiation Absorption Patterns: Human and Animal Modeling Data," *DHEW (NIOSH) Publication No. 77-183*, Sept. 1977.
58. Habegger, Gasper & Brown, "Health and Safety: Preliminary Comparative Assessment of the Satellite Power System (SPS) and Other Energy Alternatives," *Dept. of Energy Rept. ER-0053*, April, 1980.
59. Hazzard (ed.) "Symposium on Biological Effects and Measurement of Radio Frequency/Microwaves," *HEW Publication (FDA) 77-8026*, July, 1977.
60. Hopwood, "Dowsing, Ley Lines and the Electromagnetic Link," *New Scientist*, Dec. 27, 1979, pp. 948-9.
61. Ishimaru (ed.), "Biological Effects of Electromagnetic Waves," *Radio Science*, 14:6S, Nov.-Dec. 1979.
62. Lavery, Pullman, Pullman & de Oliveira, "The Electrostatic Molecular Potential of RNA," *Nucleic Acids Research*, 8:21 (1980), pp. 5095-5111.
63. Lee, Bracken, Capon, Sarkinen, Ihle, Perry & Eyler, "Electrical and Biological Effects of Transmission Lines: A Review," *Bonneville Power Administration Rept. BPA-BIO-78-1*, June, 1977.
64. MacGregor, "A Possible Mechanism for the Influence of Electromagnetic Radiation on Neuroelectric Potentials," *IEEE Trans. on Microwave Theory and Techniques*, Nov. 1979, pp. 914-921.
65. Matusow, "NIOSH Probes Bio-Effects of RF Heat Sealer Leakage," *Microwaves*, Oct. 1980, pp. 17.
66. McAuliffe, "I Sing the Body Electric," *Omni*, Nov. 1980, pp. 70-73.
67. Newsom, "Research Plan for Study of Biological and Ecological Effects of the Solar Power Satellite Transmission System," *NASA Contractor Rept. 3044*, August, 1978.

68. Peyton (ed.), *Biological Effects of Microwave Radiation*, New York: Plenum Press, 1961.
69. Plonsey, *Bioelectric Phenomena*, McGraw-Hill, 1969.
70. Pullman, Perahia & Cauchy, "The Molecular Electrostatic Potential of the B-DNA Helix," *Nucleic Acids Research*, 6:12 (1979) pp. 3821-3829.
71. Reeves & Sutko, "Sodium-Calcium Exchange Activity Generates a Current in Cardiac Membrane Vesicles," *Science*, June, 1980, pp. 1461-1463.
72. Robinette, Silverman & Jablon, "Effects Upon Health of Occupational Exposure to Microwave Radiation (Radar)," *American Journal of Epidemiology*, 112 (1980) pp. 39-53.
73. Samars & Cheung, "Microwave Hyperthermia for Cancer Therapy," Preprint to be published in *Critical Reviews in Bioengineering*, CRC Press.
74. Schmitt, Schneider & Crothers, *Functional Linkage in Biomolecular Systems*, New York: Raven Press, 1975.
75. Sharp, "Some Perspectives on Research Into the Biological Response to Non-Ionizing Electromagnetic Radiation," *Radio Science*, Jan.-Feb. 1979, pp. 5-10.
76. Sheppard, Bawin & Adey, "Possible Mechanisms of Weak Electromagnetic Field Coupling in Brain Tissue," *Bioelectrochemistry and Bioenergetics*, 5 (1978), pp. 67-76.
77. Snyder, "Brain Peptides as Neurotransmitters," *Science*, Aug. 29, 1980, pp. 976-83.
78. Soyka & Edmonds, *The Ion Effect*, Bantam, 1977.
79. Steneck, Cook, Vander & Kane, "The Origins of U.S. Safety Standards for Microwave Radiation," *Science*, June 13, 1980, pp. 1230-1237.
80. Sterzer, Paglione, Nowogrodzki, Beck, Mendecki, Friedenthal & Botstein, "Microwave Apparatus for the Treatment of Cancer," *Microwave Journal*, January, 1980, pp. 39-44.
81. Stuchly, "Interaction of Radiofrequency and Microwave Radiation with Living Systems," *Radiation and Environmental Biophysics*, 16 (1979), pp. 1-14.
82. Szent-Gyorgyi, "The Study of Energy Levels in Biochemistry," *Nature*, Aug. 9, 1941, pp. 157-159.

83. Taylor, "Microwave Antenna Implanted in the Human Brain," *IEEE Antennas and Propagation Society Newsletter*, Oct. 1980, pp. 10-11.
84. Tenforde (ed.), *Magnetic Field Effect on Biological Systems*, New York: Plenum Press, 1978.
85. Toler & Seals, "RF Dielectric Properties Measurement System: Human and Animal Data," *DHEW (NIOSH) Publication No. 77-176*, July, 1977.
86. Wei, "A New Theory of Nerve Conduction," *IEEE Spectrum*, Sept. 1966, pp. 123-127.
87. Weiss, "Cellular Dynamics," *Reviews of Modern Physics*, Jan. 1959, pp. 11-20.
88. Weiss, "Interactions Between Cells," *Reviews of Modern Physics*, April, 1959, pp. 449-454.
89. Weymouth, "The Electrical Connection," *New Yorker*, Nov. 24, 1980, pp. 26-47, and Dec. 1, 1980, pp. 44-58.
90. --- "Biological Effects of Ionizing Radiation, Pertinent Federal Laws and Regulations," *NIH Publication No. 79-2060*, August, 1979.
91. --- "Fifth Report on Program for Control of Electromagnetic Pollution of the Environment: The Assessment of Biological Hazards of Nonionizing Electromagnetic Radiation," *NTIA Rept. 79-19*, March, 1979.
92. --- "Ion Generators: Old Fad, New Fashion," *Science*, Oct. 1980, pp. 31-32.
93. --- "Ions Affect Health, Behavior," *Electronics*, Feb. 26, 1960, p. 45.
94. --- "Microwaves Seek and Help Destroy Cancers," *Microwaves*, Jan. 1980, p. 17.
95. --- "New Exposure Standards Set and Cancer Detected," *Microwave System News*, May, 1980, pp. 109-111.
96. --- "Pulsed Energy Goes Into Clinics," *Electronics*, July 31, 1959, pp. 42-43.
97. --- "Radiofrequency Radiation Dosimetry Handbook," *USAF School of Aerospace Medicine Rept. SAM-TR-76-35*, Sept. 1976.
98. --- "A Technical Review of the Biological Effects of Non-Ionizing Radiation," Washington, D.C.: *Office of Science and Technology Policy Rept.* May 15, 1978.

APPENDIX:

Questionnaire Used During Telephone Interviews



## QUESTIONS ABOUT THE EFFECTS OF ELECTROMAGNETIC FIELDS ON THE HUMAN BODY

### General

1. What are the mechanisms by which fields interact with the body on different geometric scales (whole-organism, organ, cellular, subcellular, molecular, atomic, subatomic)?
2. What symptoms or observed effects result from these interactions, particularly with respect to low level, long term exposures?
3. What is the difference between ionizing and nonionizing radiation?
4. Are present ANSI exposure standards adequate, in the senses that they reflect present understanding of how fields affect the body and that they provide protection from verified, temporary, reversible effects?
5. What epidemiological studies have demonstrated a (positive or negative) relationship between electromagnetic fields and the body?
6. By what axioms or laws do experimental results on animals apply to humans?

## Physiology

7. What electric fields (in volts/meter), magnetic fields (in amps/meter), current densities (in amps/square meter), and currents (in amps) exist normally within the human body? Where do they exist and what is their purpose?
  
8. What external field (or other stimulus) is required to interfere with these fields and what are the results?
  
9. What is the role of membranes in the intereaction between fields and the body, including those which separate individual cells and parts of cells, and those which surround entire organs?
  
10. How do lipids contribute to the role of membranes?
  
11. What forces or energy levels are required to either ionize or simply decompose substances found within the body, such as proteins and DNA?
  
12. Can a nonlinear, dispersive (that is, lossy) medium such as the human body or parts thereof sustain lossless, or high-Q, modes (electromagnetic, mechanical, or other)?
  
13. Is there any evidence (theoretical or experimental) that electromagnetic energy penetrates unexpectedly far into the body by means of surface waves (that is, by following the boundary between dissimilar media)?

## Medicine

14. What different frequencies and field intensities are used for hyperthermia and why?
  
15. What different frequencies and field intensities are used for bone healing and why?
  
16. What is the role of electromagnetic fields and/or electric currents in treating disorders of the: nervous system, cardiovascular system, pancreas, gastro-intestinal system, other systems?

## Conclusions

17. What other questions do you feel would bring out useful information?
  
18. What references and researchers would you recommend be consulted?

## BIBLIOGRAPHIC DATA SHEET

1. Report No. CR 166661	2. Government Accession No.	3. Recipient's Catalog No.	
4. Title and Subtitle Electromagnetic Field Interactions with the Human Body: Observed Effects and Theories	5. Report Date April 9, 1981		6. Performing Organization Code
	8. Performing Organization Report No.		
7. Author(s) Jeremy K. Raines	10. Work Unit No.		
9. Performing Organization Name and Address Dr. Jeremy K. Raines, P.E. 13420 Cleveland Drive Rockville, MD 20850	11. Contract or Grant NoPurchase Order No. S-75151B		13. Type of Report and Period Covered State-of-the-art Survey and Compendium
	12. Sponsoring Agency Name and Address NASA/Goddard Space Flight Center National Needs Office, Code 702 Greenbelt, MD 20771		
14. Sponsoring Agency Code 702		15. Supplementary Notes	
16. Abstract Mankind has been immersed in electromagnetic (EM) fields since his appearance on the earth. Only relatively recently has his environment included more or less coherent EM fields (from electric power lines, radio and television broadcasting, radar, lasers, etc.). Most previous studies have involved effects of "ionizing" radiation on the human body. Significantly less has been done with "non-ionizing" EM fields. This report attempts to summarize the state of published knowledge about the effects of non-ionizing EM fields on humans. Information has been collected from a variety of sources. The written sources (over 1000) included a wide variety running from journals to news articles. Other types of sources included in-person meetings, telephone interviews and lecture tapes. Of the reported 5000 pertinent documents and items that exist on the subject, it is believed that the report represents an accurate sampling of existing relevant subject matter. A major purpose of the report is to indicate that there are good, bad and benign effects to be expected from non-ionizing EM fields and much more knowledge appears necessary to properly categorize and qualify EM field characteristics. Knowledge of the boundary between categories, perhaps largely dependent on field intensity, is vital to proper future use of EM radiation for any purpose and the protection of the individual citizen from hazard. It is hoped that the report will stimulate discussion about priority and direction for the needed			
17. Key Words (Selected by Author(s)) Survey of effects of non-ionizing radiation in humans		18. Distribution Statement	
19. Security Classif. (of this report) Unclassified	20. Security Classif. (of this page) Unclassified	21. No. of Pages 123	22. Price*

**End of Document**